

Високо Квалитет
Високи технологии



КАТАЛОГ
2011





СЪДЪРЖАНИЕ

ЕНЕРГОСПЕСТЯВАЩИ ЛАМПИ.....	02	СОЛАРНИ ЛАМПИ.....	59
ЛУМИНИСЦЕНТНИ ЛАМПИ	07	ПОДОВИ ЛУНИ ЗА ВГРАЖДАНЕ ТИП ЛЕД	60
ХАЛОГЕННИ ЛАМПИ.....	08	ДИОДНА ЛЕНТА	62
ДИОДНИ ЛАМПИ.....	09	ДИОДНИ ДРАЙВЕРИ.....	63
ДИОДНИ ЛУМ. ТРЪБИ	10	СВЕТЕЩИ КАБЕЛИ.....	64
ЛАМПИ С НАЖЕЖАЕМА ЖИЧКА	11	КОНТРОЛЕРИ ЗА СВЕТЕЦ КАБЕЛ.....	64
РЕФЛЕКТОРНИ КРУШКИ.....	12	ПРЕЗАРЕЖДАЩО СЕ И АВАРИЙНО ОСВЕТЛЕНИЕ.....	65
ЖИВАЧНИ ЛАМПИ.....	13	НАСТОЛНИ ЛАМПИ.....	70
МЕТАЛ ХАЛОГЕННИ ЛАМПИ.....	13	НОЩНИ ЛАМПИ.....	73
ХАЛОГЕННИ ЛУНИ	14	ПОДОВИ ЛАМПИОНИ	74
ДИОДНИ ЛУНИ.....	19	ДЕТЕКТОР	75
ОСВЕТИТЕЛИ ЗА КАРТИНИ И ОГЛЕДАЛА.....	23	ДОМ. ЗВЪНЦИ.....	75
ТАВАНСКИ ОСВЕТИТЕЛИ.....	24	ФОТОРЕЛЕТА.....	75
СПОТ ОСВЕТИТЕЛИ	29	СЕНЗОРИ.....	75
ЛУНИ ЗА ВГРАЖДАНЕ.....	30	ДРОСЕЛИ	76
ДЕКОРАТИВНИ ТАВАНСКИ ОСВЕТИТЕЛИ.....	33	ТРАНСФОРМАТОРИ.....	76
ЕЛЕКТРОННИ СТЕННИ ОСВЕТИТЕЛИ.....	37	ФАСУНГИ.....	77
ЛУМИНИСЦЕНТНИ ОСВЕТИТЕЛНИ ТЕЛА	40	СТАРТЕРИ.....	77
ЕЛЕКТРОМАГНИТНИ СТЕННИ ОСВЕТИТЕЛИ.....	41	КЛЮЧЕ С ВЪЖЕ	78
ВЛАГОЗАЩИТЕНИ ОСВЕТИТЕЛИ.....	42	КАБЕЛНИ ПРЕВРЪЗКИ.....	78
ИНДУСТРИАЛНИ ЛАМПИ.....	43	ИЗОЛАЦИОННИ ЛЕНТИ	78
ХАЛОГЕННИ ПРОЖЕКТОРИ.....	44	КОНЕКТОР.....	78
ДИОДНИ ПРОЖЕКТОРИ	45	СКОБИ ЗА КАБЕЛ.....	78
МЕТАЛХАЛОГЕННИ ПРОЖЕКТОРИ	45	КОАКСИАЛЕН КАБЕЛ RG6.....	78
ЛАМПИ С АЛУМИНИЕВ КОРПУС.....	47	ЛУСТЕР КЛЕМИ.....	78
УЛИЧНИ ОСВЕТИТЕЛИ.....	48	КАБЕЛ УТР CAT5E.....	78
ГРАДИНСКИ ЛАМПИ	49	ВЕНТИЛАТОРИ.....	79

HL 8311 НАНО

3U T2.2
11W E27



- 220-240V / 50-60Hz
- Живот: 8000 Часа, 500 Лумена
- 2700 K / 6400 K



HL 8315 МИНИ

3U T2.8
15W E27



- 220-240V / 50-60Hz
- Живот: 8000 Часа, 720 Лумена
- 2700 K / 6400 K



HL 8315

3U T3.8
15W E27



- 220-240V / 50-60Hz
- Живот: 8000 Часа, 750 Лумена
- 2700 K / 6400 K



HL 8320

3U T3.6
20W E27



- 220-240V / 50-60Hz
- Живот: 8000 Часа, 1030 Лумена
- 2700 K / 6400 K



HL 8325

3U T3.6
25W E27



- 220-240V / 50-60Hz
- Живот: 8000 Часа, 1280 Лумена
- 2700 K / 6400 K



HL 8411 МИНИ

4U T2.8
11W E27



- 220-240V / 50-60Hz
- Живот: 8000 Часа, 495 Лумена
- 2700 K / 6400 K



HL 8415 НАНО

4U T2.2
15W E27



- 220-240V / 50-60Hz
- Живот: 8000 Часа, 700 Лумена
- 2700 K / 6400 K



HL 8420 МИНИ

4U T3
20W E27



- 220-240V / 50-60Hz
- Живот: 8000 Часа, 1030 Лумена
- 2700 K / 6400 K



HL 8434

4U T3.6
34W E27



- 220-240V / 50-60Hz
- Живот: 8000 Часа, 1730 Лумена
- 2700 K / 6400 K



HL 8445

4U T4.3
45W E27



- 220-240V / 50-60Hz
- Живот: 8000 Часа, 2290 Лумена
- 2700 K / 6400 K



HL 8465

4U T4.8
65W E27



- 220-240V / 50-60Hz
- Живот: 8000 Часа, 3500 Лумена
- 2700 K / 6400 K



HL 8585

5U T5
85W E27



- 220-240V / 50-60Hz
- Живот: 8000 Часа, 4335 Лумена
- 2700 K / 6400 K



HL 85105

5U T5
105W E27



- 220-240V / 50-60Hz
- Живот: 8000 Часа, 5355 Лумена
- 2700 K / 6400 K





HL 8609 НАНО

ПОЛУСПИРАЛА T2.2
9W E27



- 220-240V / 50-60Hz
- Живот: 8000 Часа, 450 Лумена
- 2700 K / 6400 K



HL 8611 НАНО

ПОЛУСПИРАЛА T2.2
11W E27



- 220-240V / 50-60Hz
- Живот: 8000 Часа, 560 Лумена
- 2700 K / 6400 K



HL 8615 НАНО

ПОЛУСПИРАЛА T2.2
15W E27



- 220-240V / 50-60Hz
- Живот: 8000 Часа, 740 Лумена
- 2700 K / 6400 K



HL 8620 НАНО

ПОЛУСПИРАЛА T2.2
20W E27



- 220-240V / 50-60Hz
- Живот: 8000 Часа, 985 Лумена
- 2700 K / 6400 K



HL 8623 НАНО

ПОЛУСПИРАЛА T2.2
23W E27



- 220-240V / 50-60Hz
- Живот: 8000 Часа, 1135 Лумена
- 2700 K / 6400 K



HL 8609 МИКРО

ПОЛУСПИРАЛА T2.6
9W E14



- 220-240V / 50-60Hz
- Живот: 8000 Часа, 405 Лумена
- 2700 K / 6400 K



HL 8609 МИКРО

ПОЛУСПИРАЛА T2.6
9W E27



- 220-240V / 50-60Hz
- Живот: 8000 Часа, 405 Лумена
- 2700 K / 6400 K



HL 8615 МИНИ

ПОЛУСПИРАЛА T2.8
15W E27
СИНЯ, ЧЕРВЕНА
ЗЕЛЕНА, ЖЪЛТА



- 220-240V / 50-60Hz
- Живот: 8000 Часа
- 40 лумена (Червена)
- 115 лумена (Синя)
- 230 лумена (Зелена)
- 380 лумена (Жълта)



HL 8611 МИНИ

ПОЛУСПИРАЛА T3
11W E14



- 220-240V / 50-60Hz
- Живот: 8000 Часа, 570 Лумена
- 2700 K / 6400 K



HL 8611 МИНИ

ПОЛУСПИРАЛА T3
11W E27



- 220-240V / 50-60Hz
- Живот: 8000 Часа, 570 Лумена
- 2700 K / 6400 K



HL 8615 МИНИ

ПОЛУСПИРАЛА T3
15W E14



- 220-240V / 50-60Hz
- Живот: 8000 Часа, 760 Лумена
- 2700 K / 6400 K



HL 8615 МИНИ

ПОЛУСПИРАЛА T3
15W E27



- 220-240V / 50-60Hz
- Живот: 8000 Часа, 760 Лумена
- 2700 K / 6400 K



HL 8620

ПОЛУСПИРАЛА T3.5
20W E27



- 220-240V / 50-60Hz
- Живот: 8000 Часа, 1030 Лумена
- 2700 K / 6400 K



HL 8625

ПОЛУСПИРАЛА T3.8
25W E27



- 220-240V / 50-60Hz
- Живот: 8000 Часа, 1280 Лумена
- 2700 K / 6400 K



HL 8809 НАНО

ПЪЛНА СПИРАЛА T2.2
9W E14



- 220-240V / 50-60Hz
- Живот: 8000 Часа, 390 Лумена
- 2700 K / 6400 K



HL 8809 НАНО

ПЪЛНА СПИРАЛА T2.2
9W E27



- 220-240V / 50-60Hz
- Живот: 8000 Часа, 390 Лумена
- 2700 K / 6400 K



HL 8809 НАНО

ПЪЛНА СПИРАЛА T2.2
9W G9



- 220-240V / 50-60Hz
- Живот: 8000 Часа, 390 Лумена
- 2700 K / 6400 K



HL 8809 НАНО

ПЪЛНА СПИРАЛА T2.2
9W GU10



- 220-240V / 50-60Hz
- Живот: 8000 Часа, 390 Лумена
- 2700 K / 6400 K



HL 8809 МИКРО

ПЪЛНА СПИРАЛА T2.5
9W E14



- 220-240V / 50-60Hz
- Живот: 8000 Часа, 410 Лумена
- 2700 K / 6400 K



HL 8809 МИКРО

ПЪЛНА СПИРАЛА T2.5
9W E27



- 220-240V / 50-60Hz
- Живот: 8000 Часа, 410 Лумена
- 2700 K / 6400 K



HL 8811 МИКРО

ПЪЛНА СПИРАЛА T2.5
11W E14



- 220-240V / 50-60Hz
- Живот: 8000 Часа, 475 Лумена
- 2700 K / 6400 K



HL 8811 МИКРО

ПЪЛНА СПИРАЛА T2.5
11W E27



- 220-240V / 50-60Hz
- Живот: 8000 Часа, 475 Лумена
- 2700 K / 6400 K



HL 8811 МИНИ

ПЪЛНА СПИРАЛА
T2.8
11W E14



- 220-240V / 50-60Hz
- Живот: 8000 Часа
- 580 Лумена
- 2700 K / 6400 K



HL 8811 МИНИ

ПЪЛНА СПИРАЛА
T2.8
11W E27



- 220-240V / 50-60Hz
- Живот: 8000 Часа
- 580 Лумена
- 2700 K / 6400 K



HL 8815 МИНИ

ПЪЛНА СПИРАЛА
T2.8
15W E14



- 220-240V / 50-60Hz
- Живот: 8000 Часа
- 765 Лумена
- 2700 K / 6400 K



HL 8815 МИНИ

ПЪЛНА СПИРАЛА
T2.8
15W E27



- 220-240V / 50-60Hz
- Живот: 8000 Часа
- 765 Лумена
- 2700 K / 6400 K



HL 8820

ПЪЛНА СПИРАЛА
T3.6
20W E27



- 220-240V / 50-60Hz
- Живот: 8000 Часа
- 1030 Лумена
- 2700 K / 6400 K



HL 8825

ПЪЛНА СПИРАЛА
T3.8
25W E27



- 220-240V / 50-60Hz
- Живот: 8000 Часа
- 1290 Лумена
- 2700 K / 6400 K



HL 8845

ПЪЛНА СПИРАЛА
T4.4
45W E27



- 220-240V / 50-60Hz
- Живот: 8000 Часа
- 2280 Лумена
- 2700 K / 6400 K



HL 8865

ПЪЛНА СПИРАЛА
T5.2
65W E27



- 220-240V / 50-60Hz
- Живот: 8000 Часа
- 2620 Лумена
- 2700 K / 6400 K



HL 8885

ПЪЛНА СПИРАЛА
T6
85W E27



- 220-240V / 50-60Hz
- Живот: 8000 Часа
- 4150 Лумена
- 2700 K / 6400 K



HL 88105

ПЪЛНА СПИРАЛА
T5.6
105W E27



- 220-240V / 50-60Hz
- Живот: 8000 Часа
- 5150 Лумена
- 2700 K / 6400 K





HL 8105

СВЕЩ
5W E14



- 220-240V / 50-60Hz
- Живот: 8000 Часа, 115 Лумена
- 2700 K / 6400 K



HL 8005 МИНИ

СФЕРА
5W E14



- 220-240V / 50-60Hz
- Живот: 8000 Часа, 115 Лумена
- 2700 K / 6400 K



HL 8009

POLE
9W E14



- 220-240V / 50-60Hz
- Живот: 8000 Часа, 310 Лумена
- 2700 K / 6400 K



HL 8105

СВЕЩ
5W E27



- 220-240V / 50-60Hz
- Живот: 8000 Часа, 115 Лумена
- 2700 K / 6400 K



HL 8005 МИНИ

СФЕРА
5W E27



- 220-240V / 50-60Hz
- Живот: 8000 Часа, 115 Лумена
- 2700 K / 6400 K



HL 8009

POLE
9W E27



- 220-240V / 50-60Hz
- Живот: 8000 Часа, 310 Лумена
- 2700 K / 6400 K



HL 8020

СФЕРА
20W E27



- 220-240V / 50-60Hz
- Живот: 8000 Часа, 480 Лумена
- 2700 K / 6400 K



HL 8711R

11W G5.3



- 220-240V / 50-60Hz
- Живот: 10000-15000 Часа
- 230 Лумена
- 6400 K



HL 8711R

11W GU10



- 220-240V / 50-60Hz
- Живот: 10000-15000 Часа
- 230 Лумена
- 6400 K



HL 8711D

11W GU10



- 220-240V / 50-60Hz
- Живот: 10000-15000 Часа
- 280 Лумена
- 6400 K



HL 8711D

11W G5.3



- 220-240V / 50-60Hz
- Живот: 10000-15000 Часа
- 280 Лумена
- 6400 K



HL 8109

R50
9W E14



- 220-240V / 50-60Hz
- Живот: 6000 Часа, 215 Лумена
- 6400 K



HL 8111

R63
11W E27



- 220-240V / 50-60Hz
- Живот: 6000 Часа, 202 Лумена
- 6400 K



HL 8113

R80
13W E27



- 220-240V / 50-60Hz
- Живот: 6000 Часа, 260 Лумена
- 6400 K



HL 8720

20W



- 220-240V / 50-60Hz
- Живот: 8000 Часа
- 1200 Лумена
- 6400 K



40W



NEW

- 220-240V / 50-60Hz
- Живот: 8000 Часа
- 2400 Лумена
- 6400 K



PLC

10W
13W
18W
26W



- 220-240V / 50-60Hz
- Живот: 8000 Часа
- 2700 K / 6400 K



PL

7W
9W
11W



- 220-240V / 50-60Hz
- Живот: 8000 Часа
- 2700 K / 6400 K



T4 ДНЕВНА СВЕТИНА

8W
12W
16W
20W



T5 ДНЕВНА СВЕТИНА

6W
8W
13W
21W
28W



T5 BLB

6W
8W



T8 ДНЕВНА СВЕТИНА

10W
15W
18W
30W
36W



T8 ЦВЯТ

ЗЕЛЕН
ЧЕРВЕН
СИН

18W
36W



T8 BLB

18W
36W



АДАПТОР И T5 КРЪГ

32W
ДНЕВНА СВЕТИНА



T5 КРЪГ

32W
ДНЕВНА СВЕТИНА



T9 КРЪГ

32W
ДНЕВНА СВЕТИНА



MR11 ОТВОРЕНИ



220-240V,50-60Hz
• 20W ОТВОРЕНИ
• 35W ОТВОРЕНИ



MR11 ОТВОРЕНИ



• 12V, 20W ОТВОРЕНИ
• 12V, 35W ОТВОРЕНИ



MR11 ЗАТВОРЕНИ



• 12V, 20W ЗАТВОРЕНИ
• 12V, 35W ЗАТВОРЕНИ



MR16 ОТВОРЕНИ



• 12V, 20W ОТВОРЕНИ
• 12V, 35W ОТВОРЕНИ
• 12V, 50W ОТВОРЕНИ



MR16 ЗАТВОРЕНИ



• 12V, 20W ЗАТВОРЕНИ
• 12V, 35W ЗАТВОРЕНИ
• 12V, 50W ЗАТВОРЕНИ



MR16 ЦВЕТНИ



• 12V, 50W ЗАТВОРЕНИ, ЧЕРВЕНИ
• 12V, 50W ЗАТВОРЕНИ, СИНИ
• 12V, 50W ЗАТВОРЕНИ, ЗЕЛЕНИ
• 12V, 50W ЗАТВОРЕНИ, ЖЪЛТИ



JCDR ОТВОРЕНИ



220-240V,50-60Hz
• 35W ОТВОРЕНИ
• 50W ОТВОРЕНИ
• 75W ОТВОРЕНИ



JCDR ЗАТВОРЕНИ



220-240V,50-60Hz
• 35W ЗАТВОРЕНИ
• 50W ЗАТВОРЕНИ
• 75W ЗАТВОРЕНИ



JCDR ЦВЕТНИ



220-240V,50-60Hz
• 50W ЗАТВОРЕНА, ЧЕРВЕНА
• 50W ЗАТВОРЕНА, СИНЯ
• 50W ЗАТВОРЕНА, ЗЕЛЕНА
• 50W ЗАТВОРЕНА, ЖЪЛТА



GU10



220-240V,50-60Hz
• 35W
• 50W



JCD G6.35



220-240V,50-60Hz
• 35W
• 50W
• 75W



JC G6.35



• 12V, 50W



JC G4



• 12V, 10W
• 12V, 20W
• 12V, 35W



G9 МАТ



220-240V,50-60Hz
• 25W
• 40W



G9 ПРОЗРАЧНА



220-240V,50-60Hz
• 25W
• 40W



JC G4 БЯЛ



• 12V, 20W



G9 БЯЛ



220-240V,50-60Hz
• 25W
• 40W



78mm 100W, 150W

118mm 200W, 300W, 500W

189mm 1000W

254mm 1500W, 2000W

• 220-240V, 50-60Hz



JCDR POWER LED

- БЯЛО 6400K
- СТУДЕНО БЯЛО 4200K
- ЧЕРВЕН
- ЗЕЛЕН
- СИН
- ЖЪЛТ



• 220-240V / 50-60Hz
 • Живот: 60000-80000 Часа
 • **1x3W**



GU10 POWER LED

- БЯЛО 6400K
- СТУДЕНО БЯЛО 4200K
- ЧЕРВЕН
- ЗЕЛЕН
- СИН
- ЖЪЛТ



• 220-240V / 50-60Hz
 • Живот: 60000-80000 Часа
 • **1x3W**



JDR POWER LED

- БЯЛО 6400K
- СТУДЕНО БЯЛО 4200K
- ЧЕРВЕН
- ЗЕЛЕН
- СИН
- ЖЪЛТ



• 220-240V / 50-60Hz
 • Живот: 60000-80000 Часа
 • **1x3W**



JCDR POWER LED

- БЯЛО 6400K
- СТУДЕНО БЯЛО 4200K
- ЧЕРВЕН
- ЗЕЛЕН
- СИН
- ЖЪЛТ



• 220-240V / 50-60Hz
 • Живот: 60000-80000 Часа
 • **3x1W**



GU10 POWER LED

- БЯЛО 6400K
- СТУДЕНО БЯЛО 4200K
- ЧЕРВЕН
- ЗЕЛЕН
- СИН
- ЖЪЛТ



• 220-240V / 50-60Hz
 • Живот: 60000-80000 Часа
 • **3x1W**



JDR POWER LED

- БЯЛО 6400K
- СТУДЕНО БЯЛО 4200K
- ЧЕРВЕН
- ЗЕЛЕН
- СИН
- ЖЪЛТ



• 220-240V / 50-60Hz
 • Живот: 60000-80000 Часа
 • **3x1W**



GU10 COB LED

СТУДЕНО БЯЛО
 4200 K

NEW



• 220-240V / 50-60Hz
 • Живот: 60000-80000 Часа
 • **3W**



GU10 COB LED

СТУДЕНО БЯЛО
 4200 K

NEW



• 220-240V / 50-60Hz
 • Живот: 60000-80000 Часа
 • **5W**



JCDR LED

- БЯЛ
- ЧЕРВЕН
- ЗЕЛЕН
- СИН
- ЖЪЛТ

1.2W



- 220-240V / 50-60Hz
- Живот: 60000-80000 Часа



GU10 LED

- БЯЛ
- ЧЕРВЕН
- ЗЕЛЕН
- СИН
- ЖЪЛТ

1.2W



- 220-240V / 50-60Hz
- Живот: 60000-80000 Часа



E27 LED

- БЯЛ
- ЧЕРВЕН
- ЗЕЛЕН
- СИН
- ЖЪЛТ

1.2W



- 220-240V / 50-60Hz
- Живот: 60000-80000 Часа



SMD ДИОДНИ ЛУМ.ТРЪБИ 60cm

ДНЕВНА СВЕТЛИНА 6400K

10W

NEW



- 220-240V / 50-60Hz
- Живот: 50000 Часа



SMD ДИОДНИ ЛУМ.ТРЪБИ 120cm

ДНЕВНА СВЕТЛИНА 6400K

19W

NEW



- 220-240V / 50-60Hz
- Живот: 50000 Часа



HL 440L

- БЯЛ
- ЧЕРВЕН
- ЗЕЛЕН
- СИН
- ЖЪЛТ



- 220-240V / 50-60Hz
- Живот: 20000 Часа
- 6W
- 360 лумена



Диодни лампи / Лампи с нажежаема жичка

HL 415

ЛНЖ МИНИ



10W
ПРОЗРАЧНИ

• 220-240V / 50-60Hz
• Живот: 1000 Часа



HL 416

ЛНЖ МИНИ



10W
ПРОЗРАЧНИ

• 220-240V / 50-60Hz
• Живот: 1000 Часа



HL 417

ИНДИКАТОРНА
ЛАМПА



15W
МАТОВИ

• 220-240V / 50-60Hz
• Живот: 1000 Часа



HL 420

СВЕЩ
ЛНЖ
ТИП ПЛАМЪК



40W
60W
ПРОЗРАЧНИ

• 220-240V / 50-60Hz
• Живот: 1000 Часа



HL 421

СВЕЩ
ЛНЖ
ТИП ПЛАМЪК



40W
60W
МАТОВИ

• 220-240V / 50-60Hz
• Живот: 1000 Часа



HL 423

СВЕЩ
ЛНЖ



40W
60W
ПРОЗРАЧНИ

• 220-240V / 50-60Hz
• Живот: 1000 Часа



HL 424

СВЕЩ
ЛНЖ



40W
60W
МАТОВИ

• 220-240V / 50-60Hz
• Живот: 1000 Часа



HL 425

СВЕЩ
ЛНЖ



40W
60W
СОФТ

• 220-240V / 50-60Hz
• Живот: 1000 Часа



HL 426

ЛНЖ
СВЕЩ
ЛНЖ



40W
60W
МАТОВИ

• 220-240V / 50-60Hz
• Живот: 1000 Часа



HL 427

ЛНЖ
СВЕЩ
ЛНЖ



40W
60W
ПРОЗРАЧНИ

• 220-240V / 50-60Hz
• Живот: 1000 Часа



HL 428

СВЕЩ
ЛНЖ



40W
60W
МАТОВИ

• 220-240V / 50-60Hz
• Живот: 1000 Часа



HL 429

СВЕЩ
ЛНЖ



40W
60W
СОФТ

• 220-240V / 50-60Hz
• Живот: 1000 Часа



HL 430

СФЕРА
ЛНЖ



40W
60W
СОФТ

• 220-240V / 50-60Hz
• Живот: 1000 Часа



HL 431

СФЕРА
ЛНЖ



40W
60W
МАТОВИ

• 220-240V / 50-60Hz
• Живот: 1000 Часа



HL 432

СФЕРА
ЛНЖ



40W
60W
СОФТ

• 220-240V / 50-60Hz
• Живот: 1000 Часа

HL 433

СФЕРА
ЛНЖ



40W
60W
МАТОВИ

• 220-240V / 50-60Hz
• Живот: 1000 Часа



HL 434

ЛНЖ
ЛНЖ



60W
МАТОВИ

• 220-240V / 50-60Hz
• Живот: 1000 Часа



HL 435

ЛНЖ
ЛНЖ



60W
СОФТ

• 220-240V / 50-60Hz
• Живот: 1000 Часа



R39



30W
МАТОВИ

- 220-240V / 50-60Hz
- Живот: 1000 Часа

R50



40W - 60W
МАТОВИ

- 220-240V / 50-60Hz
- Живот: 1000 Часа

R63



60W
МАТОВИ

- 220-240V / 50-60Hz
- Живот: 1000 Часа

R80



60W - 75W - 100W
МАТОВИ

- 220-240V / 50-60Hz
- Живот: 1000 Часа

R50



40W
ЖЪЛТ

- 220-240V / 50-60Hz
- Живот: 1000 Часа

R50



40W
ЧЕРВЕН

- 220-240V / 50-60Hz
- Живот: 1000 Часа

R50



40W
СИН

- 220-240V / 50-60Hz
- Живот: 1000 Часа

R50



40W
ЗЕЛЕН

- 220-240V / 50-60Hz
- Живот: 1000 Часа

R63



60W
ЖЪЛТ

- 220-240V / 50-60Hz
- Живот: 1000 Часа

R63



60W
ЧЕРВЕН

- 220-240V / 50-60Hz
- Живот: 1000 Часа

R63



60W
СИН

- 220-240V / 50-60Hz
- Живот: 1000 Часа

R63



60W
ЗЕЛЕН

- 220-240V / 50-60Hz
- Живот: 1000 Часа

R80



60W
ЖЪЛТ

- 220-240V / 50-60Hz
- Живот: 1000 Часа

R80



60W
ЧЕРВЕН

- 220-240V / 50-60Hz
- Живот: 1000 Часа

R80



60W
СИН

- 220-240V / 50-60Hz
- Живот: 1000 Часа

R80



60W
ЗЕЛЕН

- 220-240V / 50-60Hz
- Живот: 1000 Часа

Рефлекторни лампи/ Метал халогенни и Живачни лампи

HL 400

ЖИВАЧНА ЛАМПА
125W
С ДРОСЕЛ



• 220-240V / 50-60Hz



HL 401

ЖИВАЧНА ЛАМПА
125W



• 220-240V / 50-60Hz



HL 406

МЕТАЛ
ХАЛОГЕННА
ЛАМПА
150W



• 220-240V / 50-60Hz



HL 407

МЕТАЛ
ХАЛОГЕННА
ЛАМПА
150W



• 220-240V / 50-60Hz



HL 402

ЖИВАЧНА ЛАМПА
160W



• 220-240V / 50-60Hz



HL 403

ЖИВАЧНА ЛАМПА
250W
С ДРОСЕЛ



• 220-240V / 50-60Hz



HL 408

МЕТАЛ
ХАЛОГЕННА
ЛАМПА
250W



• 220-240V / 50-60Hz



HL 409

МЕТАЛ
ХАЛОГЕННА
ЛАМПА
400W

БЯЛ
СИН
ЗЕЛЕН
ЧЕРВЕН



• 220-240V / 50-60Hz



HL 404

ЖИВАЧНА ЛАМПА
250W



• 220-240V / 50-60Hz



HL 405

ЖИВАЧНА ЛАМПА
400W
С ДРОСЕЛ



• 220-240V / 50-60Hz



HL 410



• 220-240V / 50-60Hz



HL 411



• 220-240V / 50-60Hz



HL 800

ПРОЗРАЧНИ
СИН
ЖЪЛТ
КАФЯВ
ЛИЛАВ

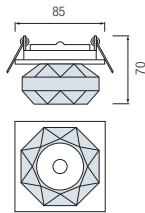

- Работно напрежение: 220-240V / 50-60Hz
- Max 20W

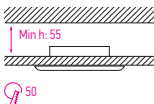

HL 801

ПРОЗРАЧНИ
СИН
ЖЪЛТ
КАФЯВ
ЛИЛАВ

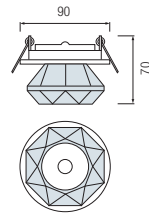

- Работно напрежение: 220-240V / 50-60Hz
- Max 20W

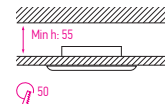

HL 802

ПРОЗРАЧНИ
СИН
ЖЪЛТ
КАФЯВ
ЛИЛАВ

NEW

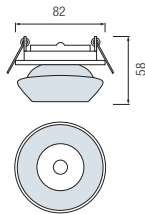

- Работно напрежение: 220-240V / 50-60Hz
- Max 20W

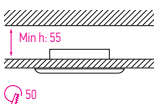

HL 803

ПРОЗРАЧНИ
СИН
ЖЪЛТ
КАФЯВ
ЛИЛАВ

NEW

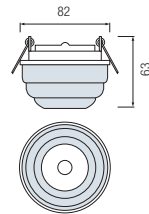

- Работно напрежение: 220-240V / 50-60Hz
- Max 20W

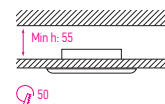

HL 804

ПРОЗРАЧНИ
СИН
ЖЪЛТ
КАФЯВ
ЛИЛАВ

NEW

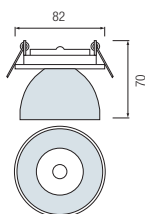

- Работно напрежение: 220-240V / 50-60Hz
- Max 20W

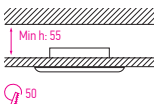

HL 805

ПРОЗРАЧНИ
СИН
ЖЪЛТ
КАФЯВ
ЛИЛАВ

NEW

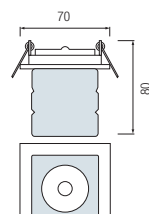

- Работно напрежение: 220-240V / 50-60Hz
- Max 20W

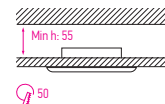

HL 799

ХРОМ
МАТ ХРОМ
ЗЛАТО
АНТИЧНО ЗЕЛЕНО
АНТИК ЧЕРВЕНА МЕД
ТИТАН ЧЕРНО/ЗЛАТО
ПЕРЛЕНО СРЕБРО/ЗЛАТО

NEW



• Работно напрежение:
220-240V / 50-60Hz
• Max 50W

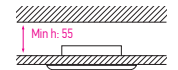
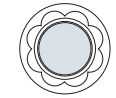
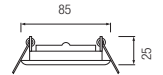

70



HL 797

ХРОМ
МАТ ХРОМ
ЗЛАТО
АНТИЧНО ЗЕЛЕНО
АНТИК ЧЕРВЕНА МЕД
ТИТАН ЧЕРНО/ЗЛАТО
ПЕРЛЕНО СРЕБРО/ЗЛАТО



• Работно напрежение:
220-240V / 50-60Hz
• Max 50W

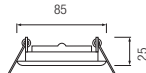

70



HL 798

ХРОМ
МАТ ХРОМ
ЗЛАТО
АНТИЧНО ЗЕЛЕНО
АНТИК ЧЕРВЕНА МЕД
ТИТАН ЧЕРНО/ЗЛАТО
ПЕРЛЕНО СРЕБРО/ЗЛАТО



• Работно напрежение:
220-240V / 50-60Hz
• Max 50W

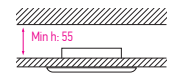
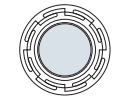
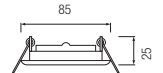

70



HL 759

ХРОМ
МАТ ХРОМ
ЗЛАТО
АНТИЧНО ЗЕЛЕНО
АНТИК ЧЕРВЕНА МЕД
ТИТАН ЧЕРНО/ЗЛАТО
ПЕРЛЕНО СРЕБРО/ЗЛАТО



• Работно напрежение:
220-240V / 50-60Hz
• Max 50W

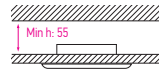
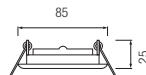

70

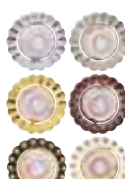

HL 779

ХРОМ
МАТ ХРОМ
ЗЛАТО
АНТИЧНО ЗЕЛЕНО
АНТИК ЧЕРВЕНА МЕД
ТИТАН ЧЕРНО/ЗЛАТО
ПЕРЛЕНО СРЕБРО/ЗЛАТО



• Работно напрежение:
220-240V / 50-60Hz
• Max 50W

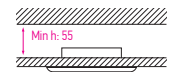
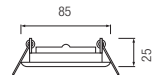

70



HL 750

ХРОМ
МАТ ХРОМ
ЗЛАТО
БЯЛ



- Работно напрежение:
220-240V / 50-60Hz
- Max 50W

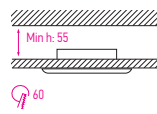
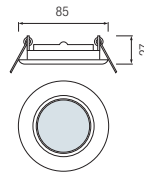

HL 751

ХРОМ
МАТ ХРОМ
ЗЛАТО
ТИТАН ЧЕРНО



- Работно напрежение:
220-240V / 50-60Hz
- Max 50W

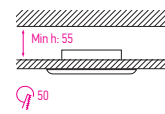
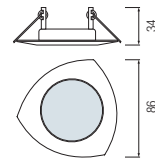

HL 753

ХРОМ
МАТ ХРОМ
ЗЛАТО
БЯЛ



- Работно напрежение:
220-240V / 50-60Hz
- Max 50W

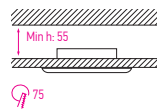
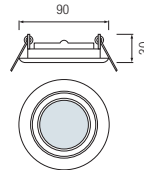

HL 752

ХРОМ
МАТ ХРОМ
ЗЛАТО
ЧЕРВЕНА МЕД
СИВО
БЯЛ



- Работно напрежение:
220-240V / 50-60Hz
- Max 50W

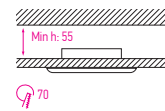
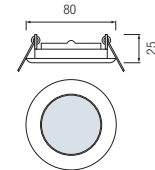

HL 754

ХРОМ
МАТ ХРОМ
ЗЛАТО
ЧЕРВЕНА МЕД
БЯЛ



- Работно напрежение:
220-240V / 50-60Hz
- Max 50W

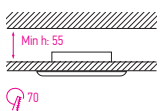
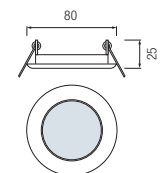

HL 755

ХРОМ
МАТ ХРОМ
ЗЛАТО



- Работно напрежение:
220-240V / 50-60Hz
- Max 50W

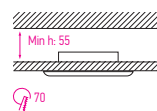
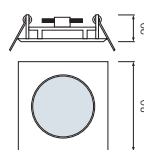

HL 756

ХРОМ
МАТ ХРОМ



- Работно напрежение:
220-240V / 50-60Hz
- Max 50W

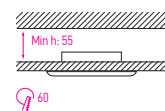
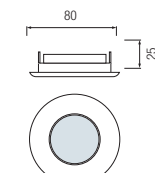

HL 760

ХРОМ
МАТ ХРОМ
ЗЛАТО

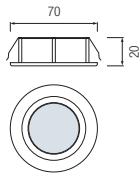

- Работно напрежение: 220-240V / 50-60Hz
- Max 20W

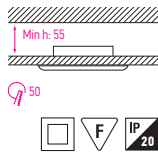

HL 761

ХРОМ
МАТ ХРОМ
ЗЛАТО

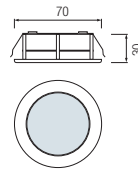

- Работно напрежение: 220-240V / 50-60Hz
- Max 20W

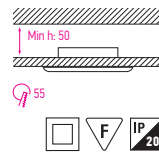

HL 762

ХРОМ
МАТ ХРОМ
ЗЛАТО

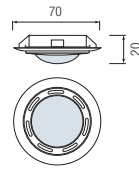

- Работно напрежение: 220-240V / 50-60Hz
- Max 20W

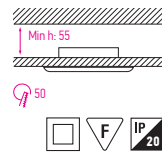

HL 763

ХРОМ
МАТ ХРОМ

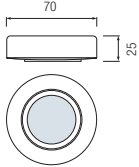

- Работно напрежение: 220-240V / 50-60Hz
- Max 20W



HL 764

ХРОМ
МАТ ХРОМ

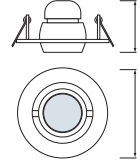

- Работно напрежение: 220-240V / 50-60Hz
- Max 20W

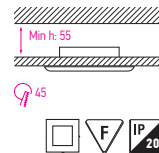

HL 765

ХРОМ
МАТ ХРОМ
ЗЛАТО

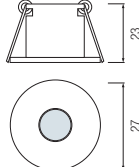

- Работно напрежение: 220-240V / 50-60Hz
- Max 20W

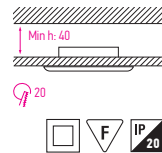

HL 766

ХРОМ
МАТ ХРОМ
ЗЛАТО
БЯЛ

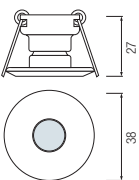
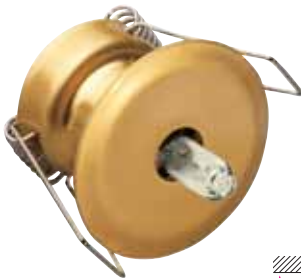

- Работно напрежение: 220-240V / 50-60Hz
- Max 20W

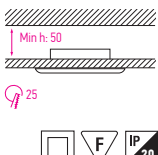

HL 767

ХРОМ
МАТ ХРОМ
ЗЛАТО

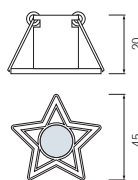

- Работно напрежение: 220-240V / 50-60Hz
- Max 20W

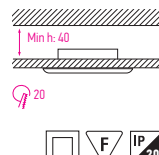

HL 768

ХРОМ
МАТ ХРОМ
ЗЛАТО

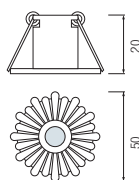

- Работно напрежение: 220-240V / 50-60Hz
- Max 20W

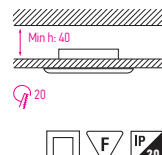

HL 769

ПРОЗРАЧНИ
СИН
РОЗОВ
ЗЕЛЕН

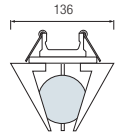

- Работно напрежение:
220-240V / 50-60Hz
- Max 50W

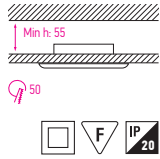

HL 770

ХРОМ
МАТ ХРОМ
ЗЛАТО

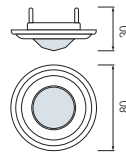

- Работно напрежение:
220-240V / 50-60Hz
- Max 50W

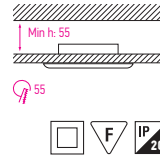

HL 771

ЗЛАТО
СРЕБРО
ТИТАН ЧЕРНО

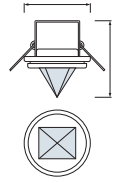

- Работно напрежение:
220-240V / 50-60Hz
- Max 50W

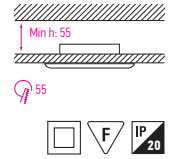

HL 773

ХРОМ
МАТ ХРОМ
ЗЛАТО

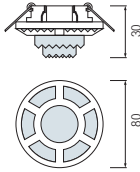

- Работно напрежение:
220-240V / 50-60Hz
- Max 50W

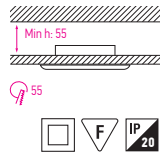

HL 774

ХРОМ
МАТ ХРОМ
БЯЛ

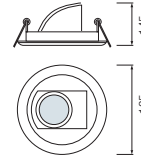

- Работно напрежение:
220-240V / 50-60Hz
- Max 50W

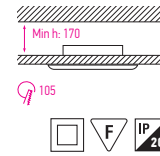

HL 775

ХРОМ
МАТ ХРОМ

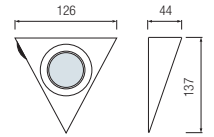

- Работно напрежение:
220-240V / 50-60Hz
- Max 20W



HL 776

ХРОМ
МАТ ХРОМ

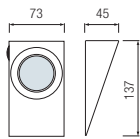

- Работно напрежение:
220-240V / 50-60Hz
- Max 20W



HL 777

ХРОМ
МАТ ХРОМ
ЗЛАТО

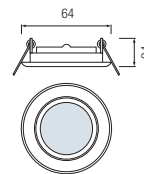

- Работно напрежение:
220-240V / 50-60Hz
- Max 35W

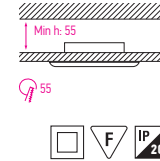

HL 778

ХРОМ
МАТ ХРОМ
ЗЛАТО

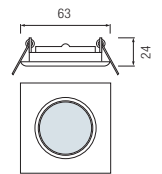

- Работно напрежение:
220-240V / 50-60Hz
- Max 35W

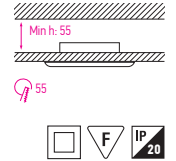

HL 670L

МАТ ХРОМ

- БЯЛО (6400K)
- ТОПЛО БЯЛО (2700K)

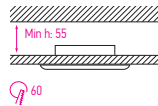
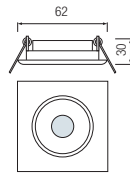

- Работно напрежение: AC220-240V / 50-60Hz
- 1W
- С трансформатор

HL 671L

МАТ ХРОМ

- БЯЛО (6400K)
- ТОПЛО БЯЛО (2700K)

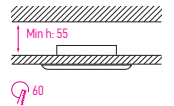
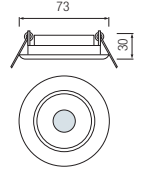

- Работно напрежение: AC220-240V / 50-60Hz
- 1W
- С трансформатор

HL 672L

ХРОМ + МАТ ХРОМ

- БЯЛО (6400K)
- ТОПЛО БЯЛО (2700K)

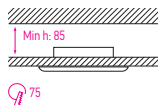
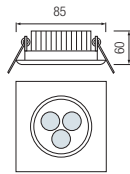

- Работно напрежение: AC220-240V / 50-60Hz
- 3W
- С трансформатор

HL 673L

ХРОМ + МАТ ХРОМ

- БЯЛО (6400K)
- ТОПЛО БЯЛО (2700K)

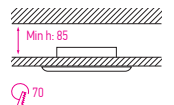
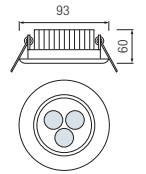

- Работно напрежение: AC220-240V / 50-60Hz
- 3W
- С трансформатор

HL 674L

ХРОМ + МАТ ХРОМ

- БЯЛО (6400K)
- ТОПЛО БЯЛО (2700K)

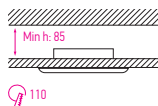
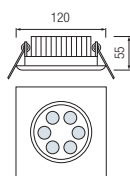

- Работно напрежение: AC220-240V / 50-60Hz
- 6W
- С трансформатор

HL 675L

ХРОМ + МАТ ХРОМ

- БЯЛО (6400K)
- ТОПЛО БЯЛО (2700K)

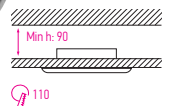
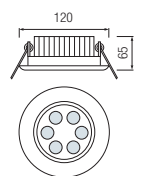

- Работно напрежение: AC220-240V / 50-60Hz
- 6W
- С трансформатор

HL 676L

ХРОМ + МАТ ХРОМ

- БЯЛО (6400K)
- ТОПЛО БЯЛО (2700K)

NEW

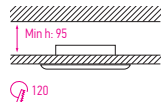
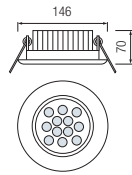

- Работно напрежение: AC220-240V / 50-60Hz
- 14W
- С трансформатор

HL 677L

ХРОМ + МАТ ХРОМ

- БЯЛО (6400K)
- ТОПЛО БЯЛО (2700K)

NEW

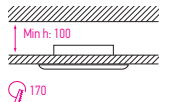
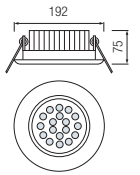

- Работно напрежение: AC220-240V / 50-60Hz
- 21W
- С трансформатор

HL 680L

МАТ ХРОМ

- БЯЛО (6400K)
- ТОПЛО БЯЛО (2700K)

NEW

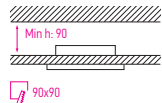
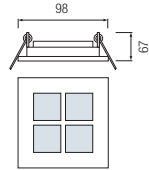

- Работно напрежение: AC220-240V / 50-60Hz
- 4W
- С трансформатор

HL 681L

МАТ ХРОМ

- БЯЛО (6400K)
- ТОПЛО БЯЛО (2700K)

NEW

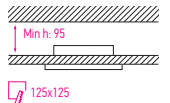
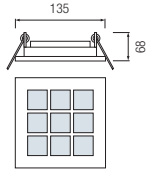

- Работно напрежение: AC220-240V / 50-60Hz
- 9W
- С трансформатор

HL 682L

МАТ ХРОМ

- БЯЛО (6400K)
- ТОПЛО БЯЛО (2700K)

NEW

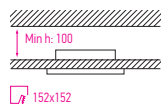
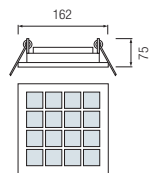
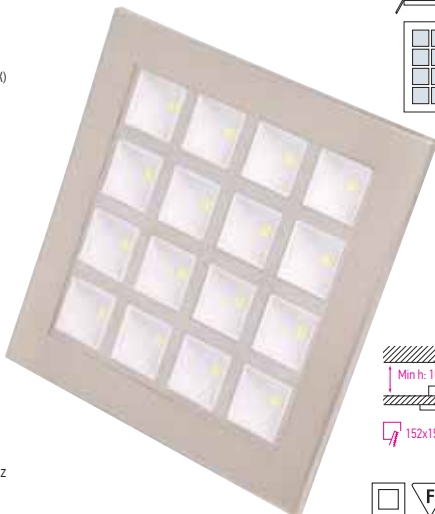

- Работно напрежение: AC220-240V / 50-60Hz
- 16W
- С трансформатор

HL 683L

МАТ ХРОМ

- БЯЛО (6400K)
- ТОПЛО БЯЛО (2700K)

NEW

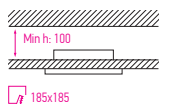
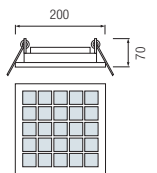

- Работно напрежение: AC220-240V / 50-60Hz
- 25W
- С трансформатор

HL 684L

БЯЛ
МАТ ХРОМ

- БЯЛ (6000К)
- ТОПЛО БЯЛО (3000К)

NEW



- Работно напрежение: AC220-240V / 50-60Hz
- 6W
- С трансформатор

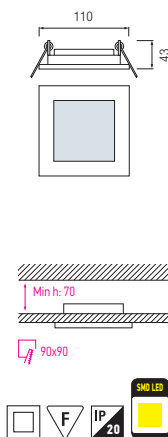

HL 687L

БЯЛ
МАТ ХРОМ

- БЯЛ (6000К)
- ТОПЛО БЯЛО (3000К)

NEW



- Работно напрежение: AC220-240V / 50-60Hz
- 6W
- С трансформатор

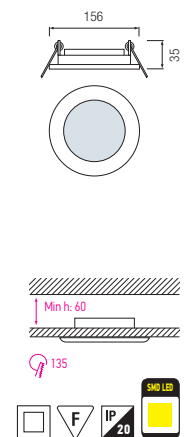

HL 685L

БЯЛ
МАТ ХРОМ

- БЯЛ (6000К)
- ТОПЛО БЯЛО (3000К)

NEW



- Работно напрежение: AC220-240V / 50-60Hz
- 12W
- С трансформатор

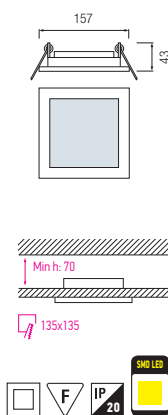

HL 688L

БЯЛ
МАТ ХРОМ

- БЯЛ (6000К)
- ТОПЛО БЯЛО (3000К)

NEW



- Работно напрежение: AC220-240V / 50-60Hz
- 12W
- С трансформатор

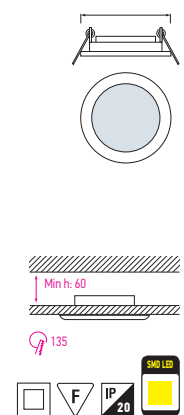

HL 686L

БЯЛ
МАТ ХРОМ

- БЯЛ (6000К)
- ТОПЛО БЯЛО (3000К)

NEW



- Работно напрежение: AC220-240V / 50-60Hz
- 15W
- С трансформатор

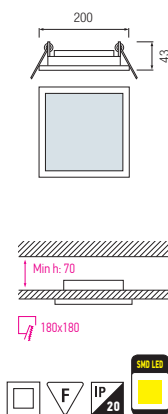

HL 689L

БЯЛ
МАТ ХРОМ

- БЯЛ (6000К)
- ТОПЛО БЯЛО (3000К)

NEW



- Работно напрежение: AC220-240V / 50-60Hz
- 15W
- С трансформатор

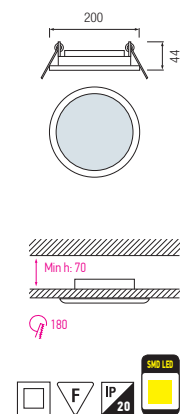

HL 690L

БЯЛ
МАТ ХРОМ

- БЯЛ (6000К)
- ТОПЛО БЯЛО (3000К)

NEW



- Работно напрежение: AC220-240V / 50-60Hz
- 16W
- С трансформатор

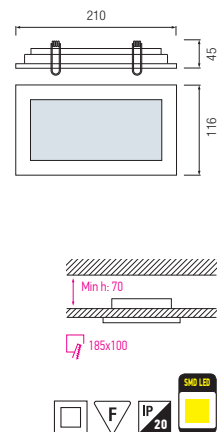

HL 695L

3 INCH

БЯЛ
МАТ ХРОМ

ТОПЛО БЯЛО (4200K)

NEW



- 220-240V / 50-60Hz
- Живот: 50.000 Часа
- **8W**

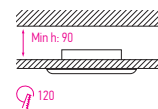
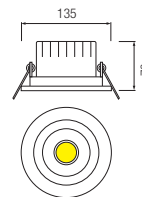

HL 696L

4 INCH

БЯЛ
МАТ ХРОМ

ТОПЛО БЯЛО (4200K)

NEW



- 220-240V / 50-60Hz
- Живот: 50.000 Часа
- **10W**

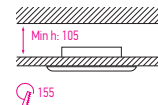
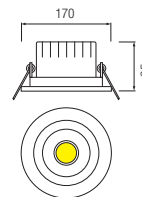

HL 697L

6 INCH

БЯЛ
МАТ ХРОМ

ТОПЛО БЯЛО (4200K)

NEW



- 220-240V / 50-60Hz
- Живот: 50.000 Часа
- **20W**

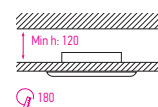
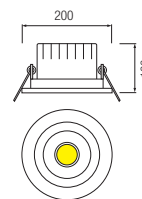

Диодни луни / Лампи за огледала и картини

HL 003L

ЧЕРВЕН
БЯЛ
ЧЕРЕН



Моля погледнете страницата 80 за други подобни продукти от серията
Моля погледнете страницата 80 за други подобни продукти от серията

- Работно напрежение: 220-240V / 50-60Hz
- 3W



NEW

HL 008L

ЧЕРВЕН
БЯЛ
ЧЕРЕН



Моля погледнете страницата 80 за други подобни продукти от серията
Моля погледнете страницата 80 за други подобни продукти от серията

- Работно напрежение: 220-240V / 50-60Hz
- 3W



NEW

HL 651

МАТ ХРОМ
ХРОМ
ЗЛАТО



Включва електронен трансформатор

- Работно напрежение: 220-240V / 50-60Hz **12V**
- Max 2x20W (JC)
- Max 2x35W (MR11)

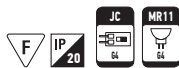

HL 656

ХРОМ
МАТ ХРОМ
ЗЛАТО



- Работно напрежение: 220-240V / 50-60Hz
- Max 100W



HL 652

ХРОМ
МАТ ХРОМ
ЗЛАТО
ТИТАН ЧЕРНО



Включва електронен трансформатор

- Работно напрежение: 220-240V / 50-60Hz **12V**
- Max 2x20W



HL 653

ХРОМ
МАТ ХРОМ
ЗЛАТО
МАТ ЗЛАТО
ТИТАН ЧЕРНО



Включва електронен трансформатор

- Работно напрежение: 220-240V / 50-60Hz
- 8W



HL 654

ХРОМ
МАТ ХРОМ
ЗЛАТО
МАТ ЗЛАТО



- Работно напрежение: 220-240V / 50-60Hz
- Max 2x40W



HL 655

ХРОМ
МАТ ХРОМ
ЗЛАТО
МАТ ЗЛАТО



- Работно напрежение: 220-240V / 50-60Hz
- Max 2x20W



HL 785N

MAT XPOM



NEW

- Работно напрежение: 220-240V / 50-60Hz
- ESL 9W



HL 787N

MAT XPOM



NEW

- Работно напрежение: 220-240V / 50-60Hz
- ESL 3x9W



HL 786N

MAT XPOM



NEW

- Работно напрежение: 220-240V / 50-60Hz
- ESL 2x9W



HL 788N

MAT XPOM



NEW

- Работно напрежение: 220-240V / 50-60Hz
- ESL 4x9W



HL 790N

XPOM



NEW

- Работно напрежение: 220-240V / 50-60Hz
- ESL 9W



HL 791N

XPOM



NEW

- Работно напрежение: 220-240V / 50-60Hz
- ESL 2x9W



HL 792N

XPOM



NEW

- Работно напрежение: 220-240V / 50-60Hz
- ESL 3x9W



HL 793N

XPOM



NEW

- Работно напрежение: 220-240V / 50-60Hz
- ESL 4x9W



HL 794N

XPOM



NEW

- Работно напрежение: 220-240V / 50-60Hz
- ESL 3x9W



HL 711

XPOM



- Работно напрежение: 220-240V / 50-60Hz
- Max 40W



HL 712

XPOM



- Работно напрежение: 220-240V / 50-60Hz
- Max 2x40W



HL 713

XPOM



- Работно напрежение: 220-240V / 50-60Hz
- Max 3x40W



HL 714

XPOM



- Работно напрежение: 220-240V / 50-60Hz
- Max 4x40W



HL 715

XPOM



- Работно напрежение: 220-240V / 50-60Hz
- Max 40W
- ESL 9W



HL 716

XPOM



- Работно напрежение: 220-240V / 50-60Hz
- Max 2x40W
- ESL 2x9W



HL 717

XPOM



- Работно напрежение: 220-240V / 50-60Hz
- Max 3x40W
- ESL 3x9W



HL 718

XPOM



- Работно напрежение: 220-240V / 50-60Hz
- Max 4x40W
- ESL 4x9W



HL 719

XPOM



- Работно напрежение: 220-240V / 50-60Hz
- Max 3x40W
- ESL 3x9W



HL 743



MAT XPOM



- Работно напрежение: 220-240V / 50-60Hz
- Max 40W



HL 744

MAT XPOM



- Работно напрежение: 220-240V / 50-60Hz
- Max 2x40W



HL 745

MAT XPOM



- Работно напрежение: 220-240V / 50-60Hz
- Max 3x40W



HL 746

MAT XPOM



- Работно напрежение: 220-240V / 50-60Hz
- Max 4x40W



HL 747

MAT XPOM



- Работно напрежение: 220-240V / 50-60Hz
- Max 3x40W



HL 748

MAT XPOM



- Работно напрежение: 220-240V / 50-60Hz
- Max 6x40W



HL 785



MAT XPOM



- Работно напрежение: 220-240V / 50-60Hz
- Max 50W



HL 788

MAT XPOM



- Работно напрежение: 220-240V / 50-60Hz
- Max 4x50W



HL 786

MAT XPOM



- Работно напрежение: 220-240V / 50-60Hz
- Max 2x50W



HL 787

MAT XPOM



- Работно напрежение: 220-240V / 50-60Hz
- Max 3x50W



HL 780



MAT ХРОМ



- Работно напрежение: 220-240V / 50-60Hz
- Max 40W

HL 781

MAT ХРОМ



- Работно напрежение: 220-240V / 50-60Hz
- Max 2x40W



HL 782

MAT ХРОМ



- Работно напрежение: 220-240V / 50-60Hz
- Max 3x40W



HL 783

MAT ХРОМ



- Работно напрежение: 220-240V / 50-60Hz
- Max 4x40W



HL 784

MAT ХРОМ



- Работно напрежение: 220-240V / 50-60Hz
- Max 3x40W



HL 790



MAT ХРОМ



- Работно напрежение: 220-240V / 50-60Hz
- Max 40W

HL 793

MAT ХРОМ



- Работно напрежение: 220-240V / 50-60Hz
- Max 4x40W



HL 791

MAT ХРОМ



- Работно напрежение: 220-240V / 50-60Hz
- Max 2x40W



HL 792

MAT ХРОМ



- Работно напрежение: 220-240V / 50-60Hz
- Max 3x40W



HL 740

ЧЕРЕН
СРЕБРО
ЗЛАТО



- Работно напрежение: 220-240V / 50-60Hz
- Max 50W



HL 741

ХРОМ

Съгло:
Матово
СИН
Розово
ЗЕЛЕН



- Работно напрежение: 220-240V / 50-60Hz
- Max 50W



HL 742

ЧЕРЕН
СРЕБРО
ЗЛАТО



- Работно напрежение: 220-240V / 50-60Hz
- Max 50W



HL 700

ХРОМ + МАТ ХРОМ



- Работно напрежение: 220-240V / 50-60Hz
- Max 40W



HL 703

ХРОМ + МАТ ХРОМ



- Работно напрежение: 220-240V / 50-60Hz
- Max 2x40W



HL 704

ХРОМ + МАТ ХРОМ



- Работно напрежение: 220-240V / 50-60Hz
- Max 3x40W



HL 701

ХРОМ + МАТ ХРОМ



- Работно напрежение: 220-240V / 50-60Hz
- Max 2x40W



HL 702

ХРОМ + МАТ ХРОМ



- Работно напрежение: 220-240V / 50-60Hz
- Max 3x40W



HL 705

ЗЛАТО + МАТ ЗЛАТО



- Работно напрежение: 220-240V / 50-60Hz
- Max 40W



HL 708

ЗЛАТО + МАТ ЗЛАТО



- Работно напрежение: 220-240V / 50-60Hz
- Max 2x40W



HL 709

ЗЛАТО + МАТ ЗЛАТО



- Работно напрежение: 220-240V / 50-60Hz
- Max 3x40W



HL 706

ЗЛАТО + МАТ ЗЛАТО



- Работно напрежение: 220-240V / 50-60Hz
- Max 2x40W



HL 707

ЗЛАТО + МАТ ЗЛАТО



- Работно напрежение: 220-240V / 50-60Hz
- Max 3x40W



HL 720

БЯЛ, ЧЕРЕН
ХРОМ
МАТ ХРОМ
ЗЛАТО



• Работно напрежение:
220-240V / 50-60Hz
• Max 40W



HL 721

БЯЛ, ЧЕРЕН
ХРОМ
МАТ ХРОМ
ЗЛАТО



• Работно напрежение:
220-240V / 50-60Hz
• Max 100W



HL 725

БЯЛ
ХРОМ
МАТ ХРОМ
ЗЛАТО



• Работно напрежение:
220-240V / 50-60Hz
• Max 3x40W



HL 722 с КЛЮЧ

БЯЛ, ЧЕРЕН
ХРОМ
МАТ ХРОМ
ЗЛАТО



• Работно напрежение:
220-240V / 50-60Hz
• Max 40W



HL 723 с КЛЮЧ

БЯЛ, ЧЕРЕН
ХРОМ
МАТ ХРОМ
ЗЛАТО



• Работно напрежение:
220-240V / 50-60Hz
• Max 100W



HL 727

БЯЛ
ХРОМ
МАТ ХРОМ
ЗЛАТО



• Работно напрежение:
220-240V / 50-60Hz
• Max 3x100W



HL 724

БЯЛ
ХРОМ
МАТ ХРОМ
ЗЛАТО



• Работно напрежение:
220-240V / 50-60Hz
• Max 2x40W



HL 728

БЯЛ, ХРОМ
МАТ ХРОМ
ЗЛАТО



• Работно напрежение:
220-240V / 50-60Hz
• Max 2x40W



HL 729

БЯЛ, ХРОМ
МАТ ХРОМ
ЗЛАТО



• Работно напрежение:
220-240V / 50-60Hz
• Max 2x100W



HL 726

БЯЛ
ХРОМ
МАТ ХРОМ
ЗЛАТО



• Работно напрежение:
220-240V / 50-60Hz
• Max 2x100W



HL 730

БЯЛ, ХРОМ
МАТ ХРОМ
ЗЛАТО



• Работно напрежение:
220-240V / 50-60Hz
• Max 3x40W



HL 731

БЯЛ, ХРОМ
МАТ ХРОМ
ЗЛАТО



• Работно напрежение:
220-240V / 50-60Hz
• Max 3x100W



HL 600
2,5" E27

ХРОМ
МАТ ХРОМ
БЯЛ

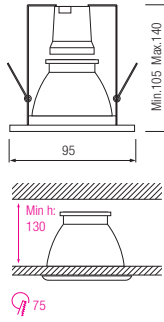

- Работно напрежение:
220-240V / 50-60Hz
- Max 40W



HL 601
2,5" PLC

ХРОМ
МАТ ХРОМ
БЯЛ

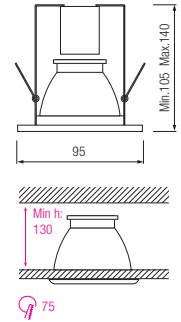

- Работно напрежение:
220-240V / 50-60Hz
- Max 10W



HL 602
3" E27

ХРОМ
МАТ ХРОМ
БЯЛ

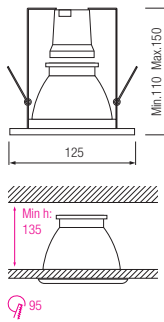

- Работно напрежение:
220-240V / 50-60Hz
- Max 60W



HL 603
3" PLC

ХРОМ
МАТ ХРОМ
БЯЛ

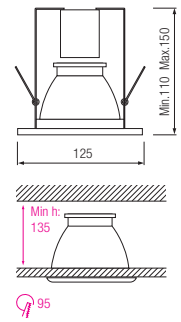

- Работно напрежение:
220-240V / 50-60Hz
- Max 13W



HL 604
4" E27

ХРОМ
МАТ ХРОМ
БЯЛ

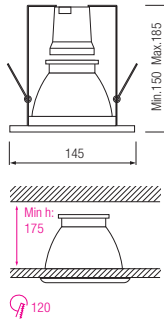

- Работно напрежение:
220-240V / 50-60Hz
- Max 60W



HL 606
5" E27

ХРОМ
МАТ ХРОМ
БЯЛ

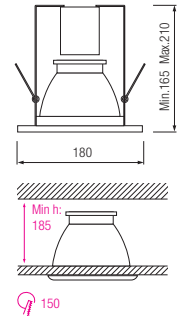

- Работно напрежение:
220-240V / 50-60Hz
- Max 75W



HL 618
8" E27

ХРОМ
МАТ ХРОМ
БЯЛ

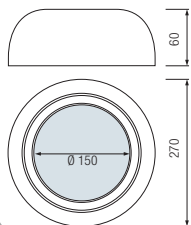

- Работно напрежение:
220-240V / 50-60Hz
- Max 2x20W



HL 621
8" Rx7S

ХРОМ
МАТ ХРОМ
БЯЛ

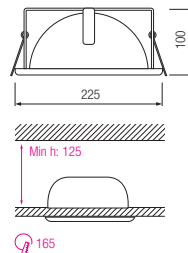

- Работно напрежение:
220-240V / 50-60Hz
- Max 150W



HL 622

ХРОМ
МАТ ХРОМ
БЯЛ

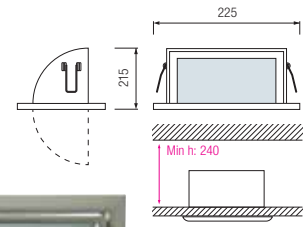

- Работно напрежение:
220-240V / 50-60Hz
- Max 150W



HL 610 6" PLC

ХРОМ
МАТ ХРОМ
БЯЛ

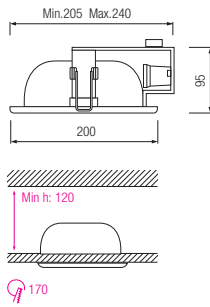

- Работно напрежение:
220-240V / 50-60Hz
- Max 2 x 18W



HL 611 6" E27

ХРОМ
МАТ ХРОМ
БЯЛ

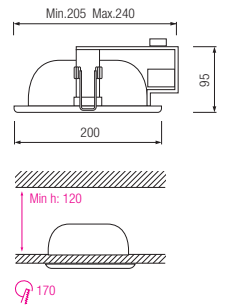

- Работно напрежение:
220-240V / 50-60Hz
- Max 2x20W



HL 612 8" E27

ХРОМ
МАТ ХРОМ
БЯЛ

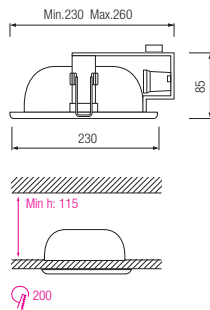

- Работно напрежение:
220-240V / 50-60Hz
- Max 2x26W



HL 613 8" PLC

ХРОМ
МАТ ХРОМ
БЯЛ

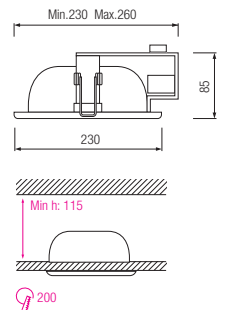

- Работно напрежение:
220-240V / 50-60Hz
- Max 2 x 26W



HL 614 6" E27

ХРОМ
МАТ ХРОМ
БЯЛ

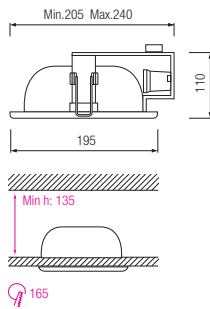

- Работно напрежение:
220-240V / 50-60Hz
- Max 2x20W



HL 615 6" PLC

ХРОМ
МАТ ХРОМ
БЯЛ

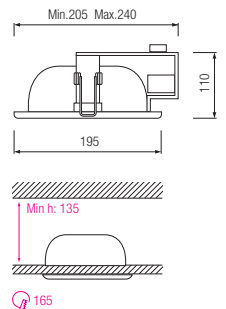

- Работно напрежение:
220-240V / 50-60Hz
- Max 2 x 18W



HL 616 8" E27

ХРОМ
МАТ ХРОМ
БЯЛ

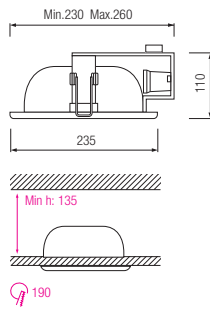

- Работно напрежение:
220-240V / 50-60Hz
- Max 2 x 25W



HL 617 8" PLC

ХРОМ
МАТ ХРОМ
БЯЛ

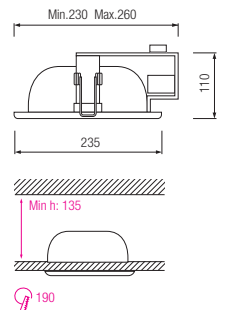

- Работно напрежение:
220-240V / 50-60Hz
- Max 2 x 26W



HL 625
6" E27

ХРОМ
МАТ ХРОМ
БЯЛ

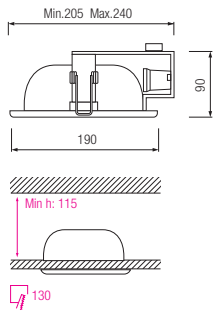

- Работно напрежение: 220-240V / 50-60Hz
- Max 2x20W



HL 626
6" PLC

ХРОМ
МАТ ХРОМ
БЯЛ

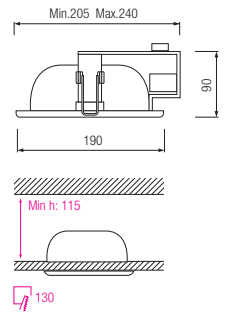

- Работно напрежение: 220-240V / 50-60Hz
- Max 2 x 18W



HL 627
8" E27

ХРОМ
МАТ ХРОМ
БЯЛ

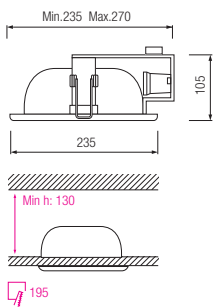

- Работно напрежение: 220-240V / 50-60Hz
- Max 2x25W



HL 628
8" PLC

ХРОМ
МАТ ХРОМ
БЯЛ

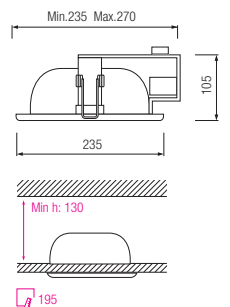

- Работно напрежение: 220-240V / 50-60Hz
- Max 2 x 26W



HL 734

ХРОМ
МАТ ХРОМ
ЗЛАТО
БЯЛ

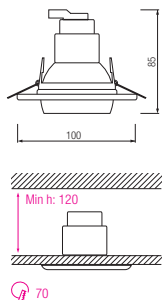

- Работно напрежение: 220-240V / 50-60Hz
- Max 40W



HL 735

ХРОМ
МАТ ХРОМ
ЗЛАТО
БЯЛ
ЧЕРЕН

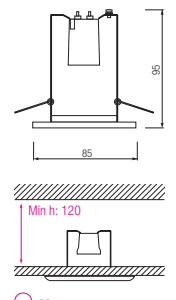

- Работно напрежение: 220-240V / 50-60Hz
- Max 40W



HL 736

ХРОМ
МАТ ХРОМ
ЗЛАТО
БЯЛ
ЧЕРЕН

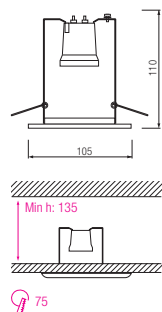

- Работно напрежение: 220-240V / 50-60Hz
- Max 60W



HL 737

ХРОМ
МАТ ХРОМ
ЗЛАТО
БЯЛ
ЧЕРЕН

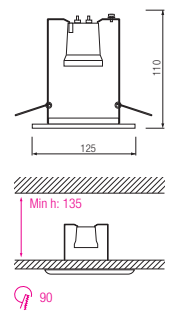

- Работно напрежение: 220-240V / 50-60Hz
- Max 100W



Луни за вграждане / Декоративни тавански осветители

HL 634S

ХРОМ + МАТ ХРОМ
Разсейвател: стъкло



- Работно напрежение: 220-240V / 50-60Hz
- Max 60W, ESL 11W



NEW

HL 634M

ХРОМ + МАТ ХРОМ
Разсейвател: стъкло



- Работно напрежение: 220-240V / 50-60Hz
- Max 60W, ESL 15W



NEW

HL 634B

ХРОМ + МАТ ХРОМ
Разсейвател: стъкло



- Работно напрежение: 220-240V / 50-60Hz
- Max 2x60W, ESL 2x15W



NEW

HL 634W

ХРОМ + МАТ ХРОМ
Разсейвател: стъкло



- Работно напрежение: 220-240V / 50-60Hz
- Max 60W, ESL 15W



NEW

HL 635S

ХРОМ + МАТ ХРОМ
Разсейвател: стъкло



- Работно напрежение: 220-240V / 50-60Hz
- Max 60W, ESL 11W



NEW

HL 635M

ХРОМ + МАТ ХРОМ
Разсейвател: стъкло



- Работно напрежение: 220-240V / 50-60Hz
- Max 60W, ESL 15W



NEW

HL 635B

ХРОМ + МАТ ХРОМ
Разсейвател: стъкло



- Работно напрежение: 220-240V / 50-60Hz
- Max 2x60W, ESL 2x15W



NEW

HL 635W

ХРОМ + МАТ ХРОМ
Разсейвател: стъкло



- Работно напрежение: 220-240V / 50-60Hz
- Max 60W, ESL 15W



NEW

HL 636S

MAT XPOМ
Разсейвател: стъкло



- Работно напрежение: 220-240V / 50-60Hz
- Max 60W, ESL 15W



NEW

HL 636M

MAT XPOМ
Разсейвател: стъкло



- Работно напрежение: 220-240V / 50-60Hz
- Max 2x60W, ESL 2x15W



NEW

HL 636B

MAT XPOМ
Разсейвател: стъкло



- Работно напрежение: 220-240V / 50-60Hz
- Max 3x60W, ESL 3x15W



NEW

HL 636W

MAT XPOМ
Разсейвател: стъкло



- Работно напрежение: 220-240V / 50-60Hz
- Max 60W, ESL 15W



NEW

HL 795

MAT XPOМ



- Работно напрежение: 220-240V / 50-60Hz
- Max 100W



HL 796

MAT XPOМ



- Работно напрежение: 220-240V / 50-60Hz
- Max 200W



HL 640

MAT ХРОМ
Разсейвател: стъкло



- Работно напрежение: 220-240V / 50-60Hz
- Max 40W
- Max 9W (ESL)



HL 641

MAT ХРОМ
Разсейвател: стъкло



- Работно напрежение: 220-240V / 50-60Hz
- Max 60W
- Max 1x15W (ESL)



HL 642

MAT ХРОМ
Разсейвател: стъкло



- Работно напрежение: 220-240V / 50-60Hz
- Max 2x60W
- Max 2x15W (ESL)



HL 643

MAT ХРОМ
Разсейвател: стъкло



- Работно напрежение: 220-240V / 50-60Hz
- Max 40W
- Max 1x11W (ESL)



HL 644

MAT ХРОМ
Разсейвател: стъкло



- Работно напрежение: 220-240V / 50-60Hz
- Max 60W
- Max 1x15W (ESL)



HL 645

MAT ХРОМ
Разсейвател: стъкло



- Работно напрежение: 220-240V / 50-60Hz
- Max 2x60W
- Max 2x15W (ESL)



HL 646

MAT ХРОМ
Разсейвател: стъкло



- Работно напрежение: 220-240V / 50-60Hz
- Max 2x40W
- Max 2x11W (ESL)



HL 647

MAT ХРОМ
Разсейвател: стъкло



- Работно напрежение: 220-240V / 50-60Hz
- Max 2x60W
- Max 2x15W (ESL)



HL 648

MAT ХРОМ
Разсейвател: стъкло



- Работно напрежение: 220-240V / 50-60Hz
- Max 2x60W
- Max 2x15W (ESL)



HL 630

ПРОЗРАЧНИ
БЯЛ
Разсейвател: ПВЦ



- Работно напрежение:
220-240V / 50-60Hz
- Max 15W (ESL)



HL 631

ПРОЗРАЧНИ
БЯЛ
Разсейвател: ПВЦ



- Работно напрежение:
220-240V / 50-60Hz
- Max 2x20W (ESL)



HL 632

МАТОВИ
БЯЛ
Разсейвател: ПВЦ



- Работно напрежение:
220-240V / 50-60Hz
- Max 2x20W (ESL)



HL 633

МАТОВИ
БЯЛ
Разсейвател: ПВЦ



- Работно напрежение:
220-240V / 50-60Hz
- Max 2x20W (ESL)



Декоративни тавански осветители / Електронни стенни осветители

HL 2001

6W, 8W, 13W
21W, 28W



• Работно напрежение:
220-240V / 50-60Hz



HL 2002

8W, 13W
21W, 28W



• Работно напрежение:
220-240V / 50-60Hz



HL 2003

13W, 21W



• Работно напрежение:
220-240V / 50-60Hz



HL 2004A

8W, 12W
16W, 20W



• Работно напрежение:
220-240V / 50-60Hz



HL 2004B

8W, 12W
16W, 20W



• Работно напрежение:
220-240V / 50-60Hz



HL 2004

8W
13W



• Работно напрежение:
220-240V / 50-60Hz



HL 2005

8W
13W



• Работно напрежение:
220-240V / 50-60Hz



HL 2006

8W, 13W



• Работно напрежение:
220-240V / 50-60Hz



HL 2008

8W
13W



• Работно напрежение:
220-240V / 50-60Hz



HL 3011

10W, 15W, 18W
30W, 36W



• Работно напрежение:
220-240V / 50-60Hz



HL 3016

10W, 15W, 18W
30W, 36W



• Работно напрежение:
220-240V / 50-60Hz



HL 3013

10W, 15W, 18W
30W, 36W



• Работно напрежение:
220-240V / 50-60Hz



HL 3013R

18W
36W



• Работно напрежение:
220-240V / 50-60Hz



HL 3017

2x18W
2x36W



• Работно напрежение:
220-240V / 50-60Hz



HL 3017R

2x18W
2x36W



• Работно напрежение:
220-240V / 50-60Hz



HL 3020

10W, 15W, 18W
30W, 36W



• Работно напрежение:
220-240V / 50-60Hz



HL 3021

11W



• Работно напрежение:
220-240V / 50-60Hz



HL 3030

10W, 15W, 18W
30W, 36W



• Работно напрежение:
220-240V / 50-60Hz



HL 160 18W

HL 161 36W



• Работно напрежение:
220-240V / 50-60Hz



HL 162 2x18W

HL 163 2x36W



• Работно напрежение:
220-240V / 50-60Hz



HL 164 18W

HL 165 36W



• Работно напрежение:
220-240V / 50-60Hz



HL 2007

- ЩЕПСЕЛ ЗА АВТОМОБИЛ ИЛИ ЕВРО ЩЕПСЕЛ
- 5m КАБЕЛ
- 8W



• Работно напрежение:
220-240V / 50-60Hz



HL 180

2x20W ВГРАДЕН МОНТАЖ

HL 184

2x40W ВГРАДЕН МОНТАЖ



- Работно напрежение: 220-240V / 50-60Hz
- С вградени дросел и стартер



HL 181

2x20W ОТКРИТ МОНТАЖ

HL 185

2x40W ОТКРИТ МОНТАЖ



- Работно напрежение: 220-240V / 50-60Hz
- С вградени дросел и стартер



HL 182

4x20W ВГРАДЕН МОНТАЖ

HL 186

4x40W ВГРАДЕН МОНТАЖ



- Работно напрежение: 220-240V / 50-60Hz
- С вградени дросел и стартер



HL 183

4x20W ОТКРИТ МОНТАЖ

HL 187

4x40W ОТКРИТ МОНТАЖ



- Работно напрежение: 220-240V / 50-60Hz
- С вградени дросел и стартер



HL 150



- Работно напрежение: 220-240V / 50-60Hz
- С вградени дросел и стартер
- Постоянен: 0.37A
- $\Delta T 65^{\circ}\text{C TW105}^{\circ}$
- Max 20W



HL 151



- Работно напрежение: 220-240V / 50-60Hz
- С вградени дросел и стартер
- Постоянен: 0.41A
- $\Delta T 65^{\circ}\text{C TW105}^{\circ}$
- Max 2x20W



HL 152



- Работно напрежение: 220-240V / 50-60Hz
- С вградени дросел и стартер
- Постоянен: 0.43A
- $\Delta T 65^{\circ}\text{C TW105}^{\circ}$
- Max 40W



HL 153



- Работно напрежение: 220-240V / 50-60Hz
- С вградени дросел и стартер
- Постоянен: 0.43A
- $\Delta T 65^{\circ}\text{C TW105}^{\circ}$
- Max 2x40W



HL 141



- Работно напрежение: 220-240V / 50-60Hz
- С вградени дросел и стартер
- Max 20W



HL 142



- Работно напрежение: 220-240V / 50-60Hz
- С вградени дросел и стартер
- Max 40W



HL 143



- Работно напрежение: 220-240V / 50-60Hz
- С вградени дросел и стартер
- Max 2x20W



HL 144



- Работно напрежение: 220-240V / 50-60Hz
- С вградени дросел и стартер
- Max 2x40W



HL 140



- Работно напрежение: 220-240V / 50-60Hz
- С вградени дросел
- Max 11W



НЕЧУПЛИВО

HL 500



- Работно напрежение: 220-240V / 50-60Hz
- PC
- ø:180mm h:900mm
- Max 40W
- Max 15W (ЕСЛ)



HL 502

- ЧЕРВЕН
- ЗЕЛЕН
- СИН
- РОЗОВ
- ПРОЗРАЧНИ



NEW



- Работно напрежение: 220-240V / 50-60Hz
- PC
- ø:255mm h:1000mm
- Max 40W
- Max 25W (ЕСЛ)



HL 501



- Работно напрежение: 220-240V / 50-60Hz
- PC
- ø:180mm h:900mm
- Max 40W
- Max 15W (ЕСЛ)



HL 505



- Работно напрежение: 220-240V / 50-60Hz
- PC
- ø:310mm h:950mm
- Max 60W
- Max 45W (ЕСЛ)



HL 506



- Работно напрежение: 220-240V / 50-60Hz
- PC
- ø:315mm h:1000mm
- Max 60W
- Max 45W (ЕСЛ)



HL 510



- Работно напрежение: 220-240V / 50-60Hz
- PC
- ø:355mm h:1000mm
- Max 60W
- Max 65W (ЕСЛ)



HL 513



- Работно напрежение: 220-240V / 50-60Hz
- PC
- ø:413mm h:1000mm
- Max 80W
- Max 65W (ЕСЛ)



HL 514



- Работно напрежение: 220-240V / 50-60Hz
- PC
- ø:413mm h:1100mm
- Max 250W



HL 100

БЯЛ
ЧЕРЕН



• Работно напрежение:
220-240V / 50-60Hz
• Max 150W



HL 101

БЯЛ
ЧЕРЕН



• Работно напрежение:
220-240V / 50-60Hz
• Max 500W



HL 102

БЯЛ
ЧЕРЕН



• Работно напрежение:
220-240V / 50-60Hz
• Max 1000W



HL 103

БЯЛ
ЧЕРЕН



• Работно напрежение:
220-240V / 50-60Hz
• Max 1500W



HL 104

БЯЛ
ЧЕРЕН



• Работно напрежение:
220-240V / 50-60Hz
• Max 150W

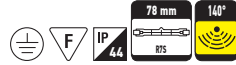

HL 105

БЯЛ
ЧЕРЕН



• Работно напрежение:
220-240V / 50-60Hz
• Max 500W



HL 106



• Работно напрежение:
220-240V / 50-60Hz
• Max 150W



HL 107



• Работно напрежение:
220-240V / 50-60Hz
• Max 500W



HL 115

БЯЛ
ЧЕРЕН
СРЕБРО



INDOOR

• Работно напрежение:
220-240V / 50-60Hz
• Max 500W



HL 108



• Работно напрежение:
220-240V / 50-60Hz
• Max 2x150W



HL 109



• Работно напрежение:
220-240V / 50-60Hz
• Max 500W



HL 110



• Работно напрежение:
220-240V / 50-60Hz
• Max 2x500W



Халогенни, Метал Халоген, Диодни Прожектори

HL 120

БЯЛ
ЧЕРЕН



- С вградени запалка, дросел, кондензатор
- Работно напрежение: 220-240V / 50-60Hz
- Max 150W



HL 120A

БЯЛ
ЧЕРЕН



- Работно напрежение: 220-240V / 50-60Hz
- Max 150W



HL 131

- С вградени запалка, дросел, кондензатор
- Работно напрежение: 220-240V / 50-60Hz
- Max 400W



HL 131A

- Работно напрежение: 220-240V / 50-60Hz
- Max 400W



HL 135

БЯЛ
СРЕБРО



- С вградени запалка, дросел, кондензатор
- Работно напрежение: 220-240V / 50-60Hz
- Max 150W



HL 136

БЯЛ
СРЕБРО



- С вградени запалка, дросел, кондензатор
- Работно напрежение: 220-240V / 50-60Hz
- Max 150W



Power Led Прожектори

HL 170L

- ЧЕРВЕН
- ЗЕЛЕН
- СИН
- БЯЛ



- Работно напрежение: 220-240V / 50-60Hz
- Живот: 50.000 часа
- 16x1W



HL 171L

ЧЕРЕН
СРЕБРО

6500K



- 220-240V / 50-60Hz
- Живот: 50.000 часа
- **10W**



NEW

HL 172L

ЧЕРЕН
СРЕБРО

6500K



- 220-240V / 50-60Hz
- Живот: 50.000 часа
- **30W**



NEW

HL 173L

ЧЕРЕН
СРЕБРО

6500K



- 220-240V / 50-60Hz
- Живот: 50.000 часа
- **50W**



NEW



Диодни прожектори / Лампи с алуминиев корпус

HL 900

БЯЛ
ЧЕРЕН



• Работно напрежение:
220-240V / 50-60Hz
• Max 60W



HL 901

БЯЛ
ЧЕРЕН



• Работно напрежение:
220-240V / 50-60Hz
• Max 60W



HL 902

БЯЛ
ЧЕРЕН



• Работно напрежение:
220-240V / 50-60Hz
• Max 60W



HL 903

БЯЛ
ЧЕРЕН
СИВО



• Работно напрежение:
220-240V / 50-60Hz
• Max 60W



HL 904

БЯЛ
ЧЕРЕН



• Работно напрежение:
220-240V / 50-60Hz
• Max 60W



HL 905

БЯЛ
ЧЕРЕН



• Работно напрежение:
220-240V / 50-60Hz
• Max 60W



HL 906

БЯЛ
ЧЕРЕН



• Работно напрежение:
220-240V / 50-60Hz
• Max 60W



HL 907

БЯЛ
ЧЕРЕН



• Работно напрежение:
220-240V / 50-60Hz
• Max 60W



HL 908

БЯЛ
ЧЕРЕН



• Работно напрежение:
220-240V / 50-60Hz
• Max 40W



HL 909

БЯЛ
ЧЕРЕН



• Работно напрежение:
220-240V / 50-60Hz
• Max 60W



HL 910

БЯЛ
ЧЕРЕН



• Работно напрежение:
220-240V / 50-60Hz
• Max 60W



HL 911

БЯЛ
ЧЕРЕН



• Работно напрежение:
220-240V / 50-60Hz
• Max 60W



HL 920

БЯЛ
ЧЕРЕН



• Работно напрежение:
220-240V / 50-60Hz
• Max 100W



HL 921

БЯЛ
ЧЕРЕН



• Работно напрежение:
220-240V / 50-60Hz
• Max 100W



HL 922

БЯЛ
ЧЕРЕН



• Работно напрежение:
220-240V / 50-60Hz
• Max 100W



HL 923

БЯЛ
ЧЕРЕН



• Работно напрежение:
220-240V / 50-60Hz
• Max 100W



HL 924

БЯЛ
ЧЕРЕН



- Работно напрежение:
220-240V / 50-60Hz
- Max 100W



HL 925

БЯЛ
ЧЕРЕН



- Работно напрежение:
220-240V / 50-60Hz
- Max 100W



HL 926

БЯЛ
ЧЕРЕН



- Работно напрежение:
220-240V / 50-60Hz
- Max 100W



HL 927

БЯЛ
ЧЕРЕН



- Работно напрежение:
220-240V / 50-60Hz
- Max 100W



HL 928

БЯЛ
ЧЕРЕН



- Работно напрежение:
220-240V / 50-60Hz
- Max 60W



HL 930

БЯЛ
ЧЕРЕН
СИВО МАТ



- Работно напрежение:
220-240V / 50-60Hz
- Max 60W



Улични осветители

HL 190



- Работно напрежение:
220-240V / 50-60Hz
- Max 60W
- Max 20W (ЕСЛ)



HL 191



- Работно напрежение:
220-240V / 50-60Hz
- Max 125W



HL 192



- Работно напрежение:
220-240V / 50-60Hz
- Max 250W



Лампи с алуминиев корпус / Улични осветители / Градински лампи

HL 295



NEW



- Работно напрежение: 220-240V / 50-60Hz
- Тяло от неръждаема стомана и галванизирана стомана
- Абанур: пластмаса
- Max 100W
- Max 20W (ESL)

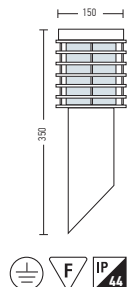

HL 296



NEW



- Работно напрежение: 220-240V / 50-60Hz
- Тяло от неръждаема стомана и галванизирана стомана
- Абанур: пластмаса
- Max 100W
- Max 20W (ESL)

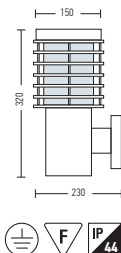

HL 297



NEW



- Работно напрежение: 220-240V / 50-60Hz
- Тяло от неръждаема стомана и галванизирана стомана
- Абанур: пластмаса
- Max 100W
- Max 20W (ESL)

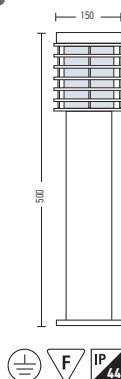

HL 298



NEW



- Работно напрежение: 220-240V / 50-60Hz
- Тяло от неръждаема стомана и галванизирана стомана
- Абанур: пластмаса
- Max 100W
- Max 20W (ESL)

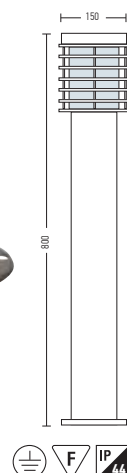

HL 200



- Работно напрежение: 220-240V / 50-60Hz
- Тяло от неръждаема стомана
- Абанур: пластмаса
- Max 60W
- Max 11W (ESL)

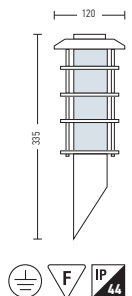

HL 201



- Работно напрежение: 220-240V / 50-60Hz
- Тяло от неръждаема стомана
- Абанур: пластмаса
- Max 60W
- Max 11W (ESL)

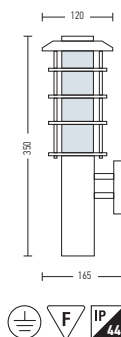

HL 202



- Работно напрежение: 220-240V / 50-60Hz
- Тяло от неръждаема стомана
- Абанур: пластмаса
- Max 60W
- Max 11W (ESL)

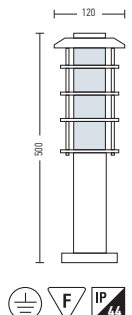

HL 203



- Работно напрежение: 220-240V / 50-60Hz
- Тяло от неръждаема стомана
- Абанур: пластмаса
- Max 60W
- Max 11W (ESL)

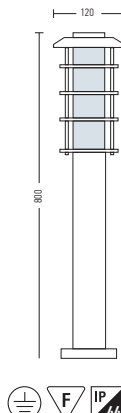

HL 205

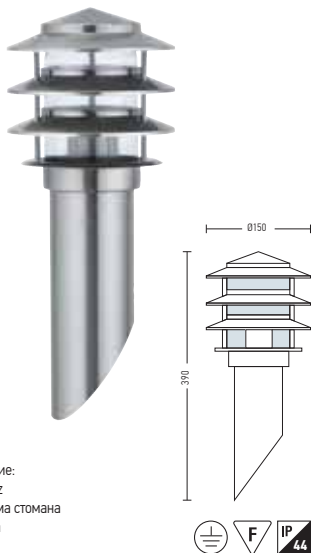

- Работно напрежение: 220-240V / 50-60Hz
- Тяло от неръждаема стомана
- Абанур: пластмаса
- Max 60W



HL 206

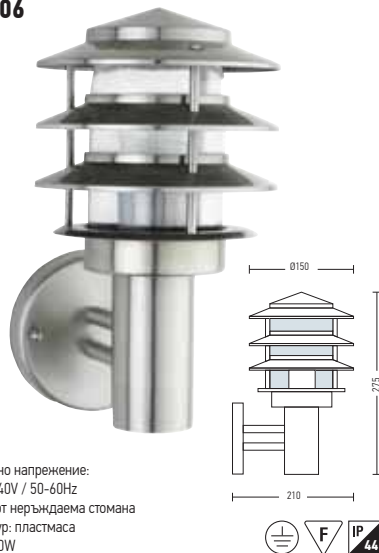

- Работно напрежение: 220-240V / 50-60Hz
- Тяло от неръждаема стомана
- Абанур: пластмаса
- Max 60W



HL 209

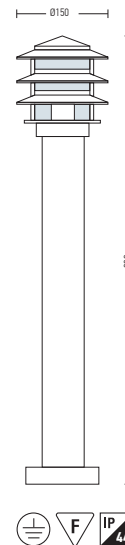

- Работно напрежение: 220-240V / 50-60Hz
- Тяло от неръждаема стомана
- Абанур: пластмаса
- Max 60W



HL 207

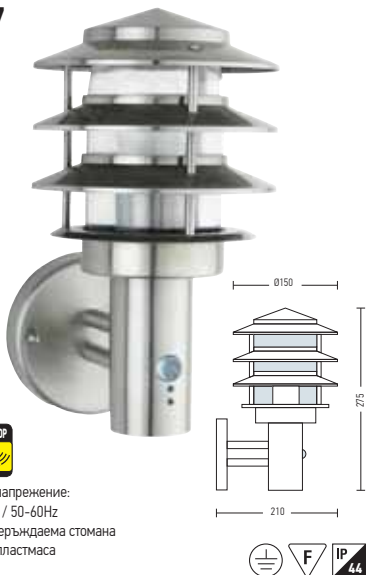

- Работно напрежение: 220-240V / 50-60Hz
- Тяло от неръждаема стомана
- Абанур: пластмаса
- Max 60W



HL 208

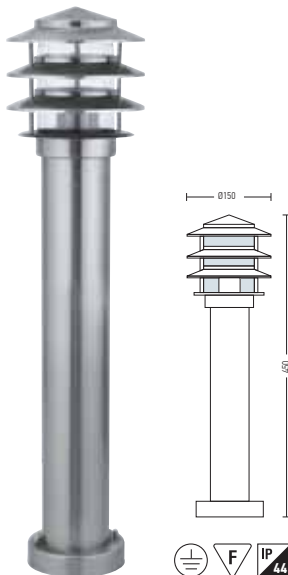

- Работно напрежение: 220-240V / 50-60Hz
- Тяло от неръждаема стомана
- Абанур: пластмаса
- Max 60W



HL 220L

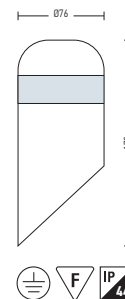

- Работно напрежение: 220-240V / 50-60Hz
- Тяло от неръждаема стомана
- Абанур: пластмаса
- Включени крушки
- За диод Max. 0.12W



HL 215

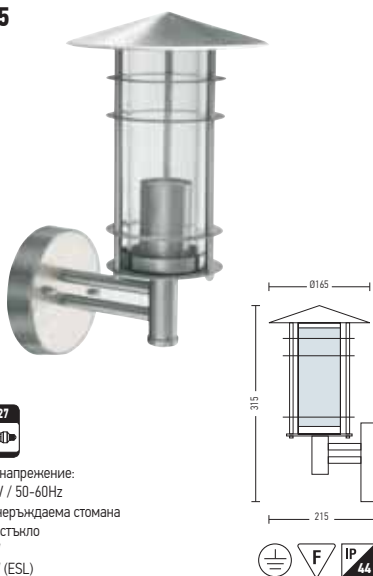

- Работно напрежение: 220-240V / 50-60Hz
- Тяло от неръждаема стомана
- Абанур: стъкло
- Max 60W
- Max 11W (ESL)



HL 216

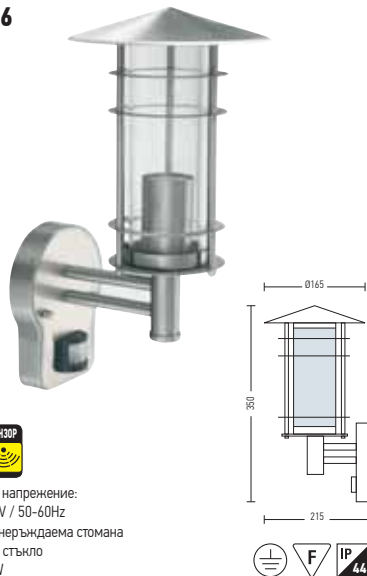

- Работно напрежение: 220-240V / 50-60Hz
- Тяло от неръждаема стомана
- Абанур: стъкло
- Max 60W



HL 221L

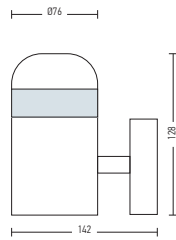

- Работно напрежение: 220-240V / 50-60Hz
- Тяло от неръждаема стомана
- Абажур: пластмаса
- Включени крушки
- За диод Max. 0.12W



HL 222L

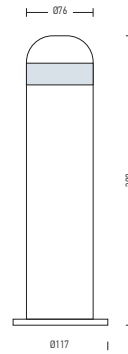

- Работно напрежение: 220-240V / 50-60Hz
- Тяло от неръждаема стомана
- Абажур: пластмаса
- Включени крушки
- За диод Max. 0.12W



HL 223L

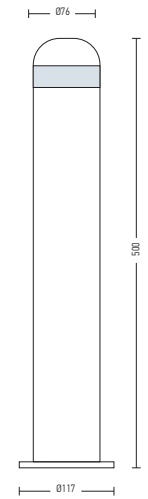

- Работно напрежение: 220-240V / 50-60Hz
- Тяло от неръждаема стомана
- Абажур: пластмаса
- Включени крушки
- За диод Max. 0.12W



HL 225L

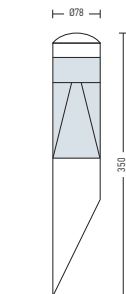

- Работно напрежение: 220-240V / 50-60Hz
- Тяло от неръждаема стомана
- Абажур: прозрачна пластмаса
- Включени крушки
- За диод Max. 0.12W



HL 226L

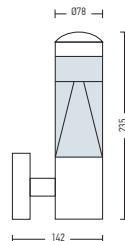

- Работно напрежение: 220-240V / 50-60Hz
- Тяло от неръждаема стомана
- Абажур: прозрачна пластмаса
- Включени крушки
- За диод Max. 0.12W



HL 227L

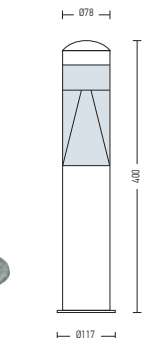

- Работно напрежение: 220-240V / 50-60Hz
- Тяло от неръждаема стомана
- Абажур: прозрачна пластмаса
- Включени крушки
- За диод Max. 0.12W



HL 228L

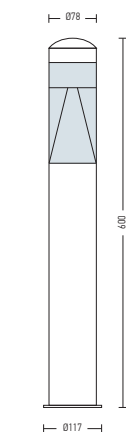

- Работно напрежение: 220-240V / 50-60Hz
- Тяло от неръждаема стомана
- Абажур: прозрачна пластмаса
- Включени крушки
- За диод Max. 0.12W



HL 230

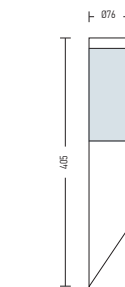

- Работно напрежение: 220-240V / 50-60Hz
- Тяло от неръждаема стомана
- Абажур: пластмаса
- Max 60W



HL 231

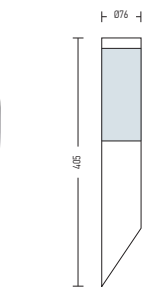

- Работно напрежение: 220-240V / 50-60Hz
- Тяло от неръждаема стомана
- Абажур: пластмаса
- Max 60W



HL 232

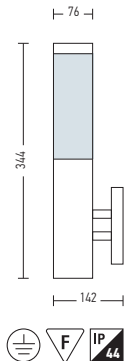

- Работно напрежение: 220-240V / 50-60Hz
- Тяло от неръждаема стомана
- Абанур: пластмаса
- Max 60W



HL 233

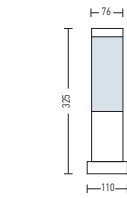

- Работно напрежение: 220-240V / 50-60Hz
- Тяло от неръждаема стомана
- Абанур: пластмаса
- Max 60W



HL 234

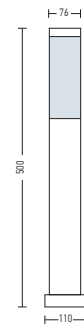

- Работно напрежение: 220-240V / 50-60Hz
- Тяло от неръждаема стомана
- Абанур: пластмаса
- Max 60W



HL 235

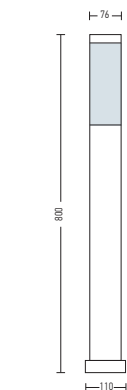

- Работно напрежение: 220-240V / 50-60Hz
- Тяло от неръждаема стомана
- Абанур: пластмаса
- Max 60W



HL 236

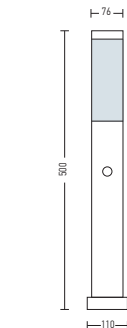

- Работно напрежение: 220-240V / 50-60Hz
- Тяло от неръждаема стомана
- Абанур: пластмаса
- Max 60W



HL 240

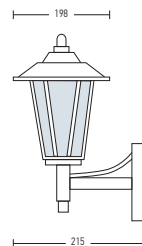

- Работно напрежение: 220-240V / 50-60Hz
- Тяло от неръждаема стомана
- Абанур: стъкло
- Max 60W



HL 241

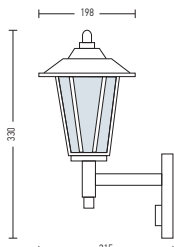

- Работно напрежение: 220-240V / 50-60Hz
- Тяло от неръждаема стомана
- Абанур: стъкло
- Max 60W



HL 242

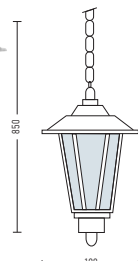

- Работно напрежение: 220-240V / 50-60Hz
- Тяло от неръждаема стомана
- Абанур: стъкло
- Max 60W



HL 243

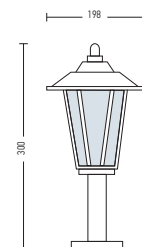

- Работно напрежение: 220-240V / 50-60Hz
- Тяло от неръждаема стомана
- Абанур: стъкло
- Max 60W



HL 244

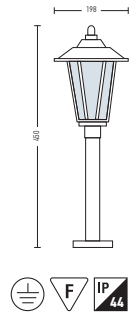

- Работно напрежение: 220-240V / 50-60Hz
- Тяло от неръждаема стомана
- Абанур: стъкло
- Max 60W



HL 245

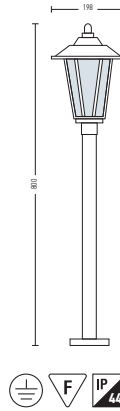

- Работно напрежение: 220-240V / 50-60Hz
- Тяло от неръждаема стомана
- Абанур: стъкло
- Max 60W



HL 245P

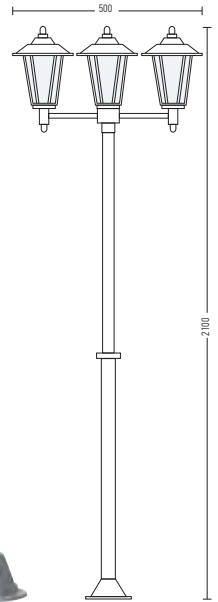
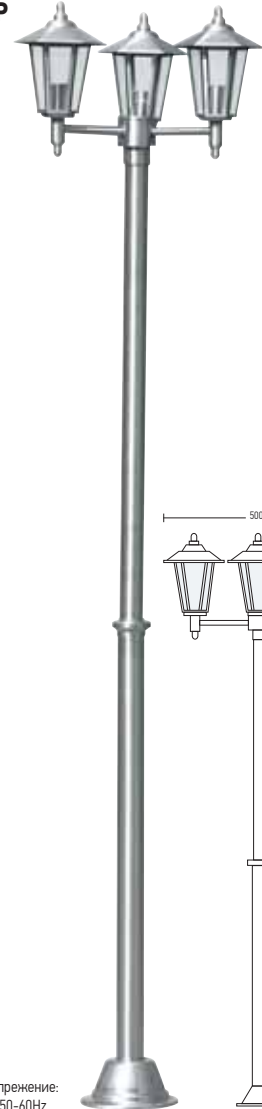

- Работно напрежение: 220-240V / 50-60Hz
- Тяло от неръждаема стомана
- Абанур: стъкло
- Max 3x60W



HL 250

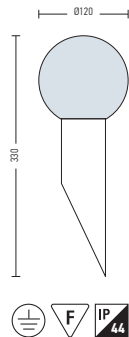

- Работно напрежение: 220-240V / 50-60Hz
- Тяло от неръждаема стомана
- Абанур: пластмаса
- Max 11W



HL 251

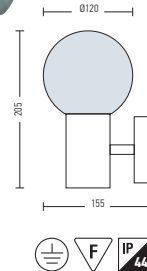

- Работно напрежение: 220-240V / 50-60Hz
- Тяло от неръждаема стомана
- Абанур: пластмаса
- Max 11W



HL 255

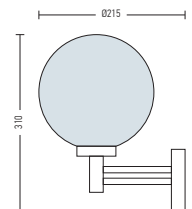

- Работно напрежение: 220-240V / 50-60Hz
- Тяло от неръждаема стомана
- Абанур: стъкло
- Max 60W
- Max 11W (ЕСЛ)



HL 252

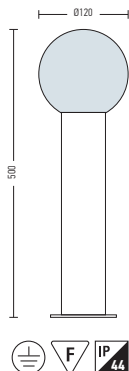

- Работно напрежение: 220-240V / 50-60Hz
- Тяло от неръждаема стомана
- Абанур: пластмаса
- Max 11W



HL 253

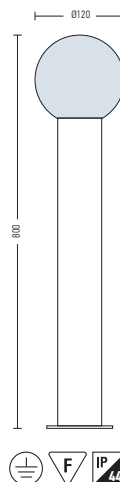

- Работно напрежение: 220-240V / 50-60Hz
- Тяло от неръждаема стомана
- Абанур: пластмаса
- Max 11W



HL 256

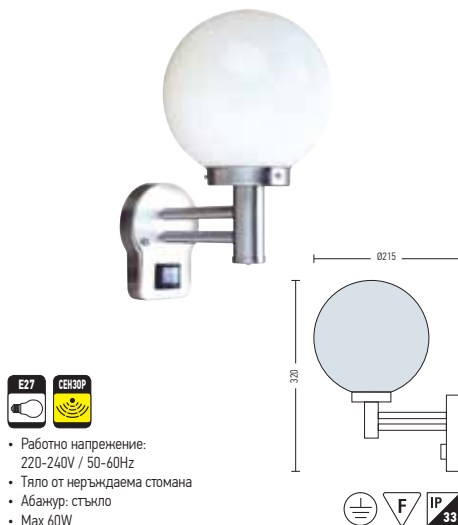

- Работно напрежение: 220-240V / 50-60Hz
- Тяло от неръждаема стомана
- Абанур: стъкло
- Max 60W



HL 257



- Работно напрежение: 220-240V / 50-60Hz
- Тяло от неръждаема стомана
- Абанур: стъкло
- Max 60W
- Max 11W (ЕСЛ)



HL 258



- Работно напрежение: 220-240V / 50-60Hz
- Тяло от неръждаема стомана
- Абанур: стъкло
- Max 60W
- Max 11W (ЕСЛ)



HL 258P

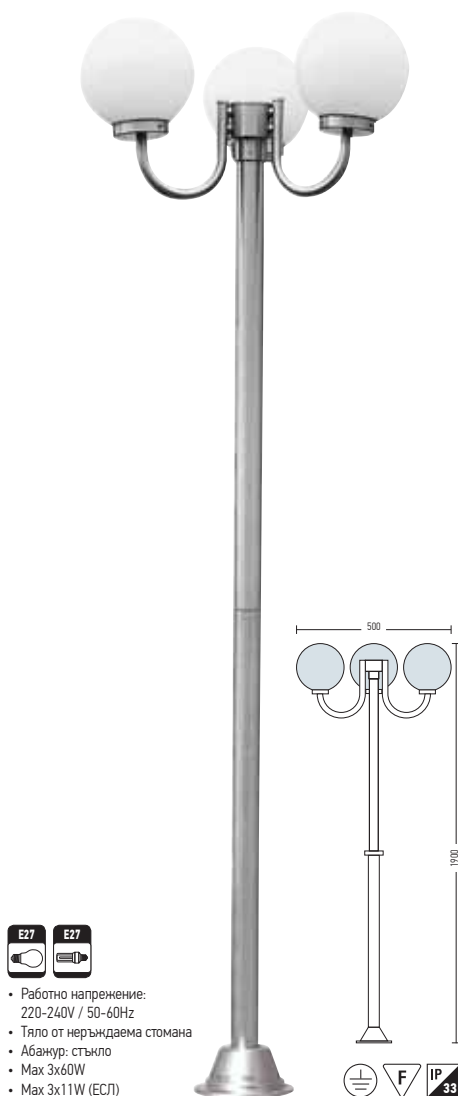

- Работно напрежение: 220-240V / 50-60Hz
- Тяло от неръждаема стомана
- Абанур: стъкло
- Max 3x60W
- Max 3x11W (ЕСЛ)



HL 260

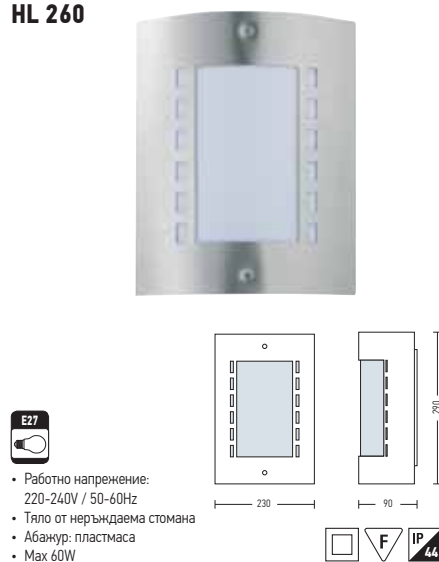

- Работно напрежение: 220-240V / 50-60Hz
- Тяло от неръждаема стомана
- Абанур: пластмаса
- Max 60W



HL 262

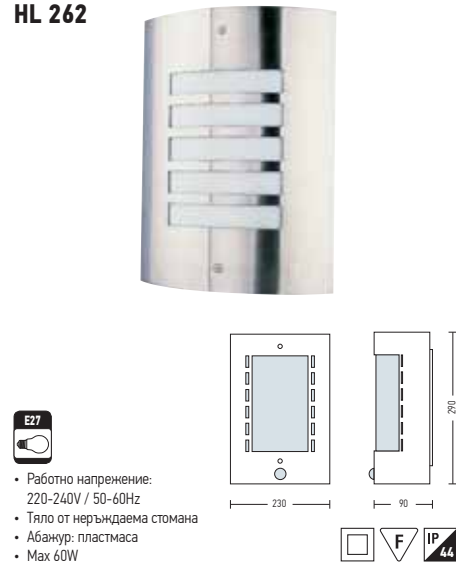

- Работно напрежение: 220-240V / 50-60Hz
- Тяло от неръждаема стомана
- Абанур: пластмаса
- Max 60W



HL 261



- Работно напрежение: 220-240V / 50-60Hz
- Тяло от неръждаема стомана
- Абанур: пластмаса
- Max 60W



HL 263

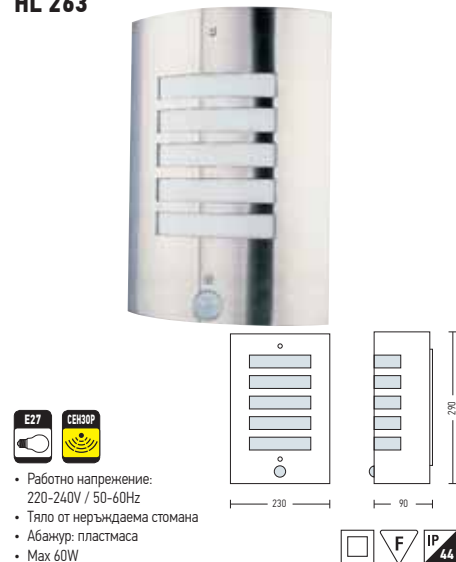

- Работно напрежение: 220-240V / 50-60Hz
- Тяло от неръждаема стомана
- Абанур: пластмаса
- Max 60W



HL 265

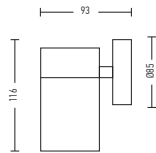

- Работно напрежение: 220-240V / 50-60Hz
- Тяло от неръждаема стомана
- Абанур: стъкло
- Max 35W



HL 266

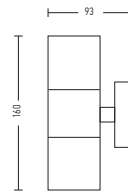

- Работно напрежение: 220-240V / 50-60Hz
- Тяло от неръждаема стомана
- Абанур: стъкло
- Max 2x35W



HL 267

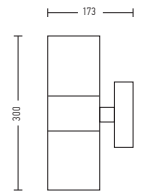

- Работно напрежение: 220-240V / 50-60Hz
- Алюминий
- Абанур: стъкло
- Max 2x11W (ЕСЛ)



HL 217

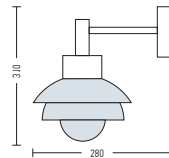

- Работно напрежение: 220-240V / 50-60Hz
- Тяло от неръждаема стомана
- Абанур: пластмаса + стъкло
- Max 60W
- Max 11W (ЕСЛ)



HL 237

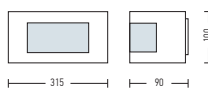

- Работно напрежение: 220-240V / 50-60Hz
- Тяло от неръждаема стомана + пластмаса
- Max 15W (ЕСЛ)



HL 238

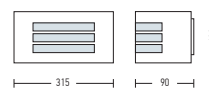

- Работно напрежение: 220-240V / 50-60Hz
- Тяло от неръждаема стомана + пластмаса
- Max 15W (ЕСЛ)



HL 239

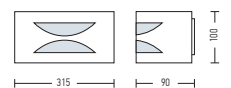

- Работно напрежение: 220-240V / 50-60Hz
- Тяло от неръждаема стомана + пластмаса
- Max 15W (ЕСЛ)



HL 246



- Работно напрежение: 220-240V / 50-60Hz
- Тяло от неръждаема стомана + пластмаса
- Max 35W

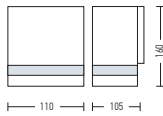

HL 247



- Работно напрежение: 220-240V / 50-60Hz
- Тяло от неръждаема стомана + пластмаса
- Max 2x35W

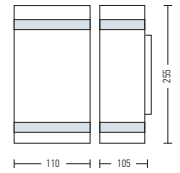

HL 248



- Работно напрежение: 220-240V / 50-60Hz
- Тяло от неръждаема стомана + пластмаса
- Max 35W

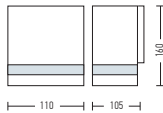

HL 249



- Работно напрежение: 220-240V / 50-60Hz
- Тяло от неръждаема стомана + пластмаса
- Max 2x35W

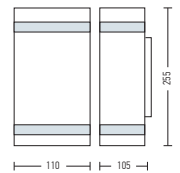

HL 218



- Работно напрежение: 220-240V / 50-60Hz
- Тяло от неръждаема стомана + пластмаса
- Max 2x11W (ЕСЛ)

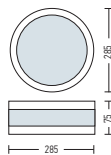

HL 219



- Работно напрежение: 220-240V / 50-60Hz
- Тяло от неръждаема стомана + пластмаса
- Max 2x11W (ЕСЛ)

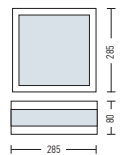

HL 270

АНТИК ЧЕРВЕНА МЕД
ЧЕРЕН
БЯЛ

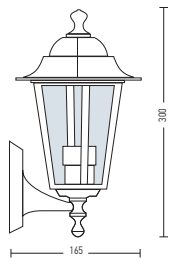

- Работно напрежение: 220-240V / 50-60Hz
- Тяло от алуминий
- Абанжур: стъкло
- Max 60W



HL 271

АНТИК ЧЕРВЕНА МЕД
ЧЕРЕН
БЯЛ

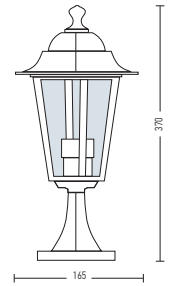

- Работно напрежение: 220-240V / 50-60Hz
- Тяло от алуминий
- Абанжур: стъкло
- Max 60W



HL 272

АНТИК ЧЕРВЕНА МЕД
ЧЕРЕН
БЯЛ

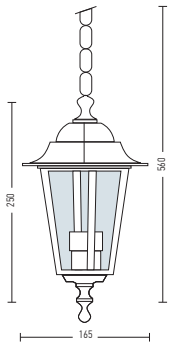

- Работно напрежение: 220-240V / 50-60Hz
- Тяло от алуминий
- Абанжур: стъкло
- Max 60W



HL 275

АНТИК ЧЕРВЕНА МЕД
ЧЕРЕН
БЯЛ

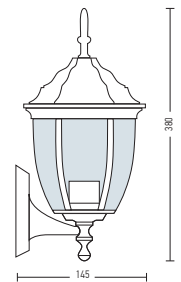

- Работно напрежение: 220-240V / 50-60Hz
- Тяло от алуминий
- Абанжур: стъкло
- Max 60W



HL 276

АНТИК ЧЕРВЕНА МЕД
ЧЕРЕН
БЯЛ

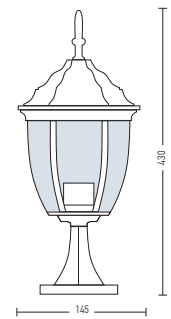

- Работно напрежение: 220-240V / 50-60Hz
- Тяло от алуминий
- Абанжур: стъкло
- Max 60W



HL 277

АНТИК ЧЕРВЕНА МЕД
ЧЕРЕН
БЯЛ

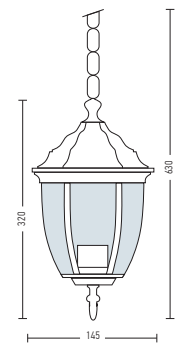

- Работно напрежение: 220-240V / 50-60Hz
- Тяло от алуминий
- Абанжур: стъкло
- Max 60W



HL 280



- Работно напрежение: 220-240V / 50-60Hz
- Тяло от алуминий
- Абажур: стъкло
- Max 50W

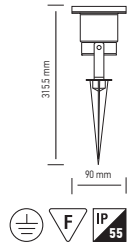

HL 281



- Работно напрежение: 220-240V / 50-60Hz
- Тяло от алуминий
- Абажур: стъкло
- Max 50W

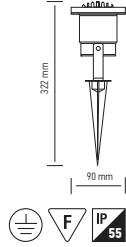

HL 282



- Работно напрежение: 220-240V / 50-60Hz
- Тяло от алуминий
- Абажур: стъкло
- Max 50W

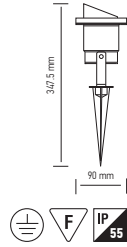

HL 285L



- Работно напрежение: 220-240V / 50-60Hz
- Нержавеющая Сталь
- 2W

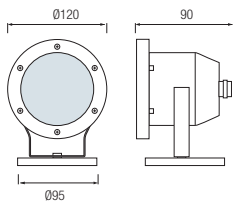

HL 286L



- Работно напрежение: 220-240V / 50-60Hz
- Нержавеющая Сталь
- 3.2W

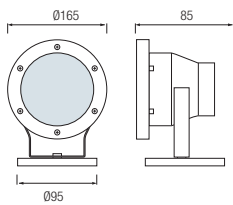

HL 290L



NEW

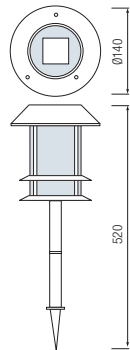

- Ni-MH AA600mAh 1.2V
- 1200-15000 cdm
- 0.24W

HL 291L



NEW

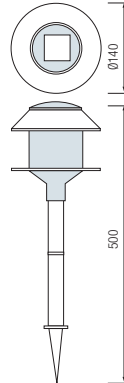

- Ni-MH AA600mAh 1.2V
- 1200-15000 cdm
- 0.12W

HL 292L



NEW

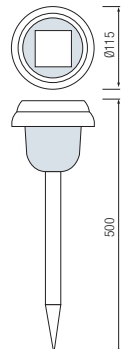

- Ni-MH AA600mAh 1.2V
- 1200-15000 cdm
- 0.12W

HL 293L



NEW

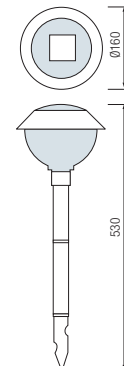

- Ni-MH AA600mAh 1.2V
- 1200-15000 cdm
- 0.12W

HL 294L



NEW

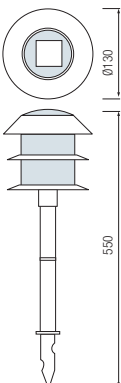

- Ni-MH AA600mAh 1.2V
- 1200-15000 cdm
- 0.12W



HL 940L

БЯЛ
СИН

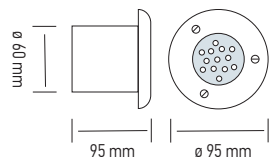

• Работно напрежение:
220-240V / 50-60Hz
• 1.2W



HL 941L

БЯЛ
СИН

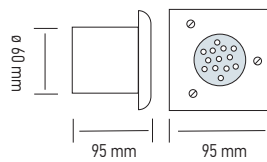

• Работно напрежение:
220-240V / 50-60Hz
• 1.2W



HL 945L

БЯЛ
СИН

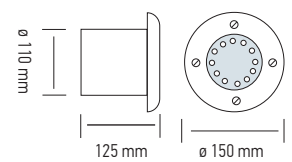

• Работно напрежение:
220-240V / 50-60Hz
• 1.8W



HL 931L

БЯЛ
СИН

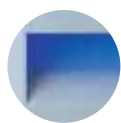
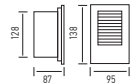

NEW

• Работно напрежение:
220-240V / 50-60Hz
• 1.5W



HL 932L

БЯЛ
СИН

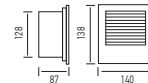

NEW

• Работно напрежение:
220-240V / 50-60Hz
• 1.8W



HL 933L

БЯЛ
СИН

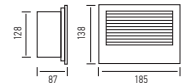

NEW

• Работно напрежение:
220-240V / 50-60Hz
• 2.7W



HL 934L

БЯЛ
СИН

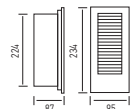

NEW

• Работно напрежение:
220-240V / 50-60Hz
• 1.5W

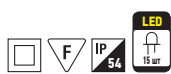

HL 935L

БЯЛ
СИН

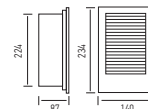

NEW

• Работно напрежение:
220-240V / 50-60Hz
• 1.8W



HL 936L

БЯЛ
СИН

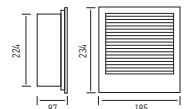

NEW

• Работно напрежение:
220-240V / 50-60Hz
• 2.7W



Подови луни за вграждане тип ЛЕД

HL 942L

БЯЛ
СИН

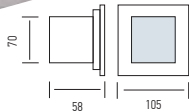

- Работно напрежение: 220-240V / 50-60Hz
- Алюминий + Нерждаема стомана, РСВ борд
- 1.6W



HL 943L

БЯЛ
СИН

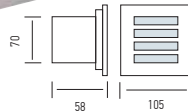

- Работно напрежение: 220-240V / 50-60Hz
- Алюминий + Нерждаема стомана, РСВ борд
- 1.6W



HL 944L

БЯЛ
СИН

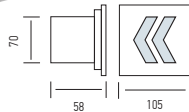

- Работно напрежение: 220-240V / 50-60Hz
- Алюминий + Нерждаема стомана, РСВ борд
- 1.6W



HL 946L

БЯЛ
СИН

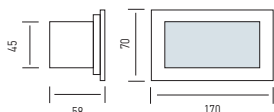

- Работно напрежение: 220-240V / 50-60Hz
- Алюминий + Нерждаема стомана, РСВ борд
- 1.6W



HL 947L

БЯЛ
СИН

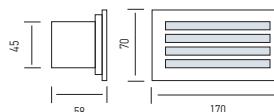

- Работно напрежение: 220-240V / 50-60Hz
- Алюминий + Нерждаема стомана, РСВ борд
- 1.6W



HL 948L

БЯЛ
СИН

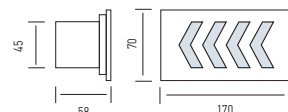

- Работно напрежение: 220-240V / 50-60Hz
- Алюминий + Нерждаема стомана, РСВ борд
- 1.6W



HL 951L

БЯЛ
СИН



NEW

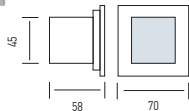

- Работно напрежение: 220-240V / 50-60Hz
- Алюминий + Нерждаема стомана, РСВ борд
- 0,9W



HL 952L

БЯЛ
СИН



NEW

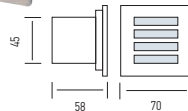

- Работно напрежение: 220-240V / 50-60Hz
- Алюминий + Нерждаема стомана, РСВ борд
- 0,9W



HL 953L

БЯЛ
СИН



NEW

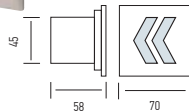

- Работно напрежение: 220-240V / 50-60Hz
- Алюминий + Нерждаема стомана, РСВ борд
- 0,9W



HL 954L

БЯЛ
СИН



NEW

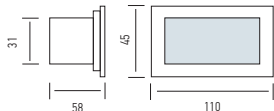

- Работно напрежение: 220-240V / 50-60Hz
- Алюминий + Нерждаема стомана, РСВ борд
- 1,2W



HL 955L

БЯЛ
СИН



NEW

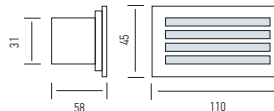

- Работно напрежение: 220-240V / 50-60Hz
- Алюминий + Нерждаема стомана, РСВ борд
- 1,2W



HL 956L

БЯЛ
СИН



NEW

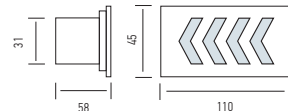

- Работно напрежение: 220-240V / 50-60Hz
- Алюминий + Нерждаема стомана, РСВ борд
- 1,2W



HL 540L

ВЛАГОЗАЩИТЕН

- Работно напрежение: 12V DC
- Входящо напрежение: 2A (1 Roll/5m)
- Мощност: 24W (1 ролка/5м)
- Стандартна дължина: 1 м / 60 лед
- Тип ЛЕД: SMD
- ЛЕД ъгъл на гледане: 120
- Опаковка: 5 м / Ролка
- Цвет на лентата: Кафяв
- С 3м самозалепваща лента за бързо инсталиране



3 светодиода правят група и всяка група може да бъде увеличена или намалена от гледна точка на продължителността на прилагане



СТУДЕНО БЯЛО



БЯЛ (6400K)



СИН



ЗЕЛЕН



ЧЕРВЕН



ЖЪЛТ



HL 541L

ВЛАГОНЕЗАЩИТЕНИ

- Работно напрежение: 12V DC
- Входящо напрежение: 2A (1 Roll/5m)
- Мощност: 24W (1 ролка/5м)
- Стандартна дължина: 1 м / 60 лед
- Тип ЛЕД: SMD
- ЛЕД ъгъл на гледане: 120
- Опаковка: 5 м / Ролка
- Цвет на лентата: Кафяв
- С 3м самозалепваща лента за бързо инсталиране

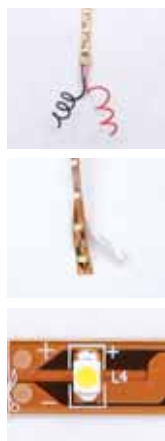

3 светодиода правят група и всяка група може да бъде увеличена или намалена от гледна точка на продължителността на прилагане



СТУДЕНО БЯЛО



БЯЛ (6400K)



СИН



ЗЕЛЕН



ЧЕРВЕН



ЖЪЛТ



HL 544

NEW



- Работно напрежение: AC 220-240V / 50-60Hz
- Изходящо напрежение: DC 12V
- Максимално ном.натоварване: 10W
- Номинален ток на натоварване: 0,8A
- За 2м диодна лента



HL 545

NEW



- Работно напрежение: AC 220-240V / 50-60Hz
- Изходящо напрежение: DC 12V
- Максимално ном.натоварване: 36W
- Номинален ток на натоварване: 3A
- За 5м диодна лента 20



HL 546

NEW



- Работно напрежение: AC 220-240V / 50-60Hz
- Изходящо напрежение: DC 12V
- Максимално ном.натоварване: 20W
- Номинален ток на натоварване: 5A
- За 10м диодна лента



HL 547

NEW



- Работно напрежение: AC 220-240V / 50-60Hz
- Изходящо напрежение: DC 12V
- Максимално ном.натоварване: 100W
- Номинален ток на натоварване: 8,5A
- За 20м диодна лента



HL 548

NEW



- Работно напрежение: AC 220-240V / 50-60Hz
- Изходящо напрежение: DC 12V
- Максимално ном.натоварване: 150W
- Номинален ток на натоварване: 12A
- За 30м диодна лента



HL 549

NEW



- Работно напрежение: AC 220-240V / 50-60Hz
- Изходящо напрежение: DC 12V
- Максимално ном.натоварване: 200W
- Номинален ток на натоварване: 17A
- За 40м диодна лента

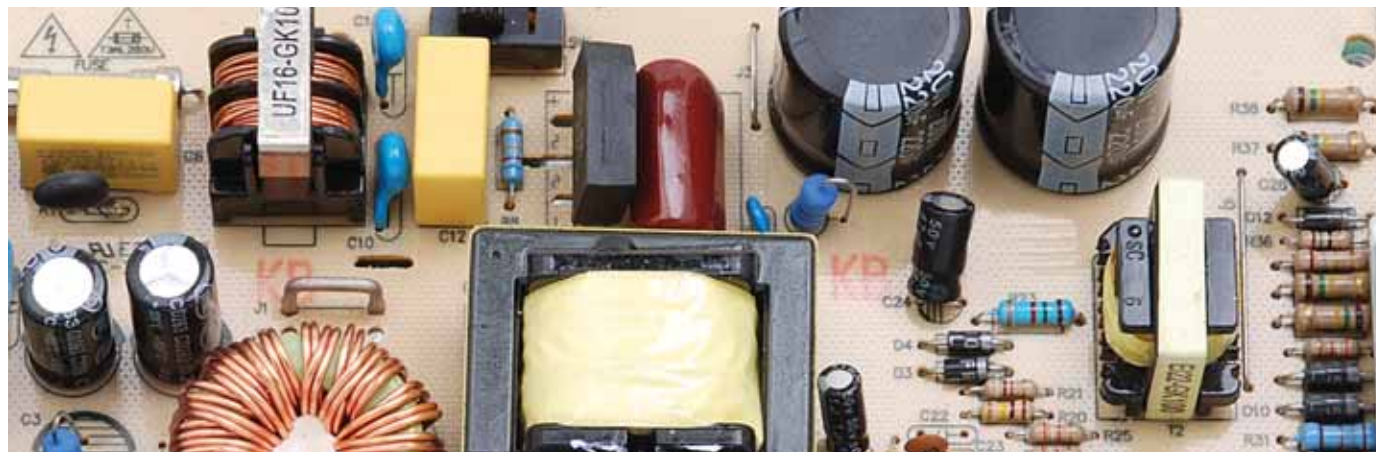

СВЕТЕЦ КАБЕЛ

2 ЛИНИИ / 3 ЛИНИИ
100 м. Ролка
13 мм
10 аксесоара



ПРОЗРАЧЕН

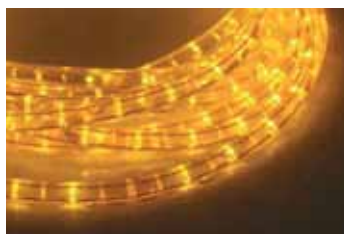

ЖЪЛТ



ЧЕРВЕН



СИН



ЗЕЛЕН



РАЗНОЦВЕТЕН

• Работно напрежение:
220-240V / 50-60Hz



СВЕТЕЦ КАБЕЛ - ЛЕД

2 ЛИНИИ / 3 ЛИНИИ
100 м. Ролка
13 мм
10 аксесоара



ПРОЗРАЧЕН



ЖЪЛТ



ЧЕРВЕН



СИН



ЗЕЛЕН



РАЗНОЦВЕТЕН

• Работно напрежение:
220-240V / 50-60Hz



Контролери за светец кабел

3 ЛИНИИ

10 m



• Работно напрежение:
220-240V / 50-60Hz
• 8 Програми
• Максимално натоварване: 200W



3 ЛИНИИ

100 m



• Работно напрежение:
220-240V / 50-60Hz
• 8 Програми
• Максимално натоварване: 1600W



HL 334L

NEW



Презареждащо се Лед Фенерче

- Работно напрежение: 220-240V / 50-60Hz
- 1W
- 4V 900mAh Презареждаща се Sealed-Acid Батерия
- Време на работа: 2,5 часа



HL 335L

NEW



Презареждащо се Лед Фенерче

- Работно напрежение: 220-240V / 50-60Hz
- 1W
- 4V 900mAh Презареждаща се Sealed-Acid Батерия
- Време на работа: 2,5 часа



HL 336L

NEW



Презареждащо се Лед Фенерче

- Работно напрежение: 220-240V / 50-60Hz
- 3W
- 4V 3Ah Презареждаща се Sealed-Acid Батерия
- Време на работа: 4 часа



HL 337L

NEW



Презареждащо се Лед Фенерче

- Работно напрежение: 220-240V / 50-60Hz
- 3W
- 6V 4,5Ah Презареждаща се Sealed-Acid Батерия
- Време на работа: 6 часа



HL 338L

NEW



Презареждащ се ЛЕД осветител

- Работно напрежение: 220-240V / 50-60Hz
- 19x1500 MCD 110° Ярна ЛЕД светлина
- 1,9W
- 4V 3Ah Презареждаща се Sealed-Acid Батерия
- Време на работа: 7 ЛЕД 24 часа, 19 ЛЕД 10 часа



HL 340

NEW



HL 339L

NEW



Презареждащ се ЛЕД осветител

- Работно напрежение: 220-240V / 50-60Hz
- 36x1500 MCD 110° Ярна ЛЕД светлина
- 3,6W
- 6V 4,5Ah Презареждаща се Sealed-Acid Батерия
- Време на работа: 16 ЛЕД 15 часа, 36 ЛЕД 6 часа



- Работно напрежение: 12V
- 35W крушка

HL 332L

NEW



Презаредящо се Лед Фенерче

- Работно напрежение: 220-240V / 50-60Hz
- 5x1500 MCD 110°
- Ярка Лед светлина
- 4V 400mAh Презаредяща се Sealed-Acid Батерия
- Време на работа: 4 часа



HL 333L

NEW



Презаредящо се Лед Фенерче

- Работно напрежение: 220-240V / 50-60Hz
- 9x1500 MCD 110°
- Ярка Лед светлина
- 4V 1.0Ah Презаредяща се Sealed-Acid Батерия
- Време на работа: 5 часа



HL 331L

NEW



Перезаряемий Светодиодный Фонарик

- Рабочее напряжение: 220-240V / 50-60Hz
- 4x1500 MCD 110°
- С ярким светодиодным Фонариком
- 4V 400mAh Перезаряемая Герметичная Кислотная Батарея
- Продолжительность Работы: 5 Часов



HL 318L



Презаредящо се Лед Фенерче

- Работно напрежение: 220-240V / 50-60Hz
- 9x1500 MCD 110°
- Ярка Лед светлина
- 4V 0.6Ah Презаредяща се Sealed-Acid Батерия
- Време на работа: 6 Лед: 8 часа
3 Лед: 16 часа



HL 324L



Презаредящо се Лед Фенерче

- Работно напрежение: 220-240V / 50-60Hz
- 19x1500 MCD 110°
- Ярка Лед светлина
- 6V 4.5Ah Презаредяща се Sealed-Acid Батерия
- Време на работа: 12 часа



HL 325L



Презаредящо се Лед Фенерче

- Работно напрежение: 220-240V / 50-60Hz
- 12x1500 MCD 110°
- Ярка Лед светлина
- 4V 3.0Ah Презаредяща се Sealed-Acid Батерия
- Време на работа: 12 часа



HL 327L



Презаредящо се Лед Фенерче

- Работно напрежение: 220-240V / 50-60Hz
- 7x1500 MCD 110°
- Ярка Лед светлина
- 4V 1.0Ah Презаредяща се Sealed-Acid Батерия
- Време на работа: 8 часа



HL 300



Презареждащо се за стенов монтаж

- Работно напрежение: 220-240V / 50-60Hz
- 1 x 20W
- 6V 4.0Ah Презареждаща се Sealed-Acid Батерия
- Време на работа: 3,5 часа
- Монтаж за стена и таван
- Аварийно и автоматично включване



HL 301



Презареждащо се за стенов монтаж

- Работно напрежение: 220-240V / 50-60Hz
- 2 x 20W
- 6V 4.0Ah Презареждаща се Sealed-Acid Батерия
- Време на работа: 1 тръба 3,5 часа
2 тръби 2 часа
- Монтаж за стена и таван
- Аварийно и автоматично включване



HL 302



Презареждащо се за стенов монтаж

- Работно напрежение: 220-240V / 50-60Hz
- 2 x 8W
- 6V 4.0Ah Презареждаща се Sealed-Acid Батерия
- Време на работа: 1 тръба 6,5 часа
2 тръби 3 часа
- Монтаж за стена и таван
- Аварийно и автоматично включване



HL 303



Презареждащо се за стенов монтаж

- Работно напрежение: 220-240V / 50-60Hz
- 2 x 8W
- 6V 2.8Ah Презареждаща се Sealed-Acid Батерия
- Време на работа: 1 тръба 5 часа
2 тръби 2,5 часа
- Монтаж за стена и таван
- Аварийно и автоматично включване



HL 323L



Презареждащо се Лед Фенерче

- Работно напрежение: 220-240V / 50-60Hz
- 35x1500 MCD 110°
- Ярка Лед светлина
- 6V 2.8Ah Презареждаща се Sealed-Acid Батерия
- Време на работа: 15 часа
- Монтаж за стена и таван
- Аварийно и автоматично включване



HL 320L



Презареждащо се Лед Фенерче

- Работно напрежение: 220-240V / 50-60Hz
- 36x1500 MCD 110°
- Ярка Лед светлина
- 4x4V 1.0Ah Презареждаща се Sealed-Acid Батерия
- Време на работа: 1 Линия 12 часа
2 Линии 6 часа
- Монтаж за стена и таван
- Аварийно и автоматично включване



HL 321L



Презареждащо се ЛЕД осветител

- Работно напрежение: 220-240V / 50-60Hz
- 60x1500 MCD 110°
- Ярка Лед светлина
- 6V 2.8Ah Презареждаща се Sealed-Acid Батерия
- Време на работа: 1 Линия 22 часа
2 Линии 12 часа
3 Линии 8 часа
- Монтаж за стена и таван
- Аварийно и автоматично включване



HL 322L



Презареждащо се ЛЕД осветител

- Работно напрежение: 220-240V / 50-60Hz
- 24x1500 MCD 110°
- Ярка Лед светлина
- 6V 2.0Ah Презареждаща се Sealed-Acid Батерия
- Време на работа: 1 линия 32 часа
2 линии 20 часа
3 линии 13 часа
- Монтаж за стена и таван
- Аварийно и автоматично включване



HL 306



Презарждащ се аварийен осветител

- Работно напрежение: 220-240V / 50-60Hz
- 1 x 6W
- 2x4V 1.0Ah Презарждаща се Sealed-Acid Батерия
- Време на работа: 90 минути
- Монтаж за стена и таван
- Аварийно и автоматично включване



HL 306L



Презарждащ се аварийен осветител

- Работно напрежение: 220-240V / 50-60Hz
- 18x1500 MCD 110°
- Ярка Лед светлина
- 2x4V 1.0Ah Презарждаща се Sealed-Acid Батерия
- Време на работа: 6 часа
- Монтаж за стена и таван
- Аварийно и автоматично включване



HL 312L

NEW



Презарждащ се Лед Фенерче

- Работно напрежение: 220-240V / 50-60Hz
- 60x1500 MCD 110°
- Ярка Лед светлина
- 4x4V 1Ah Презарждаща се Sealed-Acid Батерия
- Време на работа: Позиция 1: 10 часа Позиция 2: 4 часа



HL 308



Презарждащ се аварийен осветител

- Работно напрежение: 220-240V / 50-60Hz
- 1 x 8W
- 2x4V 1.0Ah Презарждаща се Sealed-Acid Батерия
- Време на работа: 90 минути
- Монтаж за стена и таван
- Аварийно и автоматично включване



HL 308L



Презарждащ се аварийен осветител

- Работно напрежение: 220-240V / 50-60Hz
- 24x1500 MCD 110°
- Ярка Лед светлина
- 2x4V 1.0Ah Презарждаща се Sealed-Acid Батерия
- Време на работа: 5 часа
- Монтаж за стена и таван
- Аварийно и автоматично включване



HL 313L

NEW



Презарждащ се Лед Фенерче

- Работно напрежение: 220-240V / 50-60Hz
- 32x1500 MCD 110°
- Ярка Лед светлина
- 2x4V 1Ah Презарждаща се Sealed-Acid Батерия
- Време на работа: Позиция 1: 6 часа Позиция 2: 3 часа



HL 307



Презареждащо се Инсектициден фенер

- Работно напрежение: 220-240V / 50-60Hz
- 7W UV
- 6V 4.0Ah Презареждаща се Sealed-Acid Батерия
- Време на работа: 5,5 часа
- 12V DC Адаптор



HL 310L



Презареждащо се ЛЕД Нощна лампа (E27)

- Работно напрежение: 220-240V / 50-60Hz
- 10x1500 MCD 110° Ярка Лед светлина
- 4V 1.0Ah Презареждаща се Sealed-Acid Батерия
- Време на работа: 6 часа
- Аварийно и автоматично включване
- AC / DC задействане



HL 316L



Презареждащо се Настолна лампа ЛЕД

- Работно напрежение: 220-240V / 50-60Hz
- 16x1500 MCD 110° Ярка Лед светлина
- 2x4V 1.0Ah Презареждаща се Sealed-Acid Батерия
- Време на работа: 6 часа
- AC / DC задействане
- Преносим



HL 319L



Презареждащо се Лед Фенерче

- Работно напрежение: 220-240V / 50-60Hz
- 18x1500 MCD 110° Ярка Лед светлина
- 3x1500 MCD 110° Ярка Лед светлина
- 6V 4.0Ah Презареждаща се Sealed-Acid Батерия
- Време на работа: за 18 Лед 35 часа за 3 Лед 50 часа



HL 319LR



Презареждащо се Лед фенерче с радио

- Работно напрежение: 220-240V 50/60 Hz
- 24x1500 MCD 110° Ярка Лед светлина
- 3x1500 MCD 110° Ярка Лед светлина
- 6V 2.0Ah Презареждаща се Sealed-Acid Батерия
- Време на работа: За 24 Лед: 12 часа За 3 Лед: 24 часа За радиото: 8 часа



HL 317L



Презареждащо се Лед Фенерче С Нощен Сензор

- Работно напрежение: 220-240V / 50-60Hz
- 3x1500 MCD 110° Ярка Лед светлина
- 4V 0.6Ah Презареждаща се Sealed-Acid Батерия
- Време на работа: 12 часа



HL 329L



Презареждащо се Лед Фенерче

- Работно напрежение: 220-240V / 50-60Hz
- 10x1500 MCD 110° Ярка Лед светлина
- 4V 2.0Ah Презареждаща се Sealed-Acid Батерия
- Време на работа: 10 часа
- 360° осветяемост
- Преносим



HL 330L



Аварийн Изход ЛЕД осветител

- Работно напрежение: 220-240V / 50-60Hz
- 6x1500 MCD 110° Ярка Лед светлина
- 3.6V 360mAh Презареждаща се Ni-Cd Батерия



Моля погледнете на страница 80 за други подобни продукти от тази серия

HL 001L

ЧЕРВЕН
БЯЛ
ЧЕРЕН



• Работно напрежение:
220-240V / 50-60Hz
• 3W



NEW

HL 002L

ЧЕРВЕН
БЯЛ
ЧЕРЕН



• Работно напрежение:
220-240V / 50-60Hz
• 3W



NEW

HL 006L

ЧЕРВЕН
БЯЛ
ЧЕРЕН



• Работно напрежение:
220-240V / 50-60Hz
• 3W



NEW

HL 007L

ЧЕРВЕН
БЯЛ
ЧЕРЕН



• Работно напрежение:
220-240V / 50-60Hz
• 3W



NEW

HL 011L

ЧЕРВЕН
БЯЛ
ЧЕРЕН



• Работно напрежение:
220-240V / 50-60Hz
• 3W



NEW

HL 043

СИН
ОРАНЖЕВ
ЗЕЛЕН



NEW



- Работно напрежение: 220-240V / 50-60Hz
- Max 11W



HL 044

СИН
ОРАНЖЕВ
ЗЕЛЕН

NEW



- Работно напрежение: 220-240V / 50-60Hz
- Max 11W



HL 036

СИН
РОЗОВ
ЗЕЛЕН



- Работно напрежение: 220-240V / 50-60Hz
- Max 11W



HL 037

СИН
РОЗОВ
ЗЕЛЕН



- Работно напрежение: 220-240V / 50-60Hz
- Max 11W



HL 038

СИН
РОЗОВ
ЖЪЛТ



- Работно напрежение: 220-240V / 50-60Hz
- Max 11W



HL 039

СИН
РОЗОВ
ЖЪЛТ



- Работно напрежение: 220-240V / 50-60Hz
- Max 11W



HL 041

СИН
РОЗОВ
ЖЪЛТ



- Работно напрежение: 220-240V / 50-60Hz
- Max 11W



HL 069

ЧЕРЕН
БЯЛ
ЧЕРВЕН
СИВО



- Работно напрежение: 220-240V / 50-60Hz
- Max 11W



HL 052

ПРОЗРАЧЕН
СИН
ЛИЛАВ
ЗЕЛЕН
ОРАНЖЕВ



- Работно напрежение: 220-240V / 50-60Hz
- Max 40W



HL 028

ЧЕРЕН
СИН
ЗЕЛЕН
ЧЕРВЕН
СРЕБРО
БЯЛ



- Работно напрежение: 220-240V / 50-60Hz
- Max 20W



HL 027

ЧЕРЕН
СИН
ЗЕЛЕН
СИВО
ЧЕРВЕН
СРЕБРО
БЯЛ



- Работно напрежение: 220-240V / 50-60Hz
- Max 20W



HL 065

ЧЕРЕН
СИН
ЗЕЛЕН
ЧЕРВЕН
БЯЛ



- Работно напрежение: 220-240V / 50-60Hz 12V
- Max 20W



HL 051

ЧЕРЕН
СИН
ЗЕЛЕН
ЧЕРВЕН
СРЕБРО



- Работно напрежение: 220-240V / 50-60Hz
- Max 15W (Для ЕСЛ)
- Max 40W



HL 068

ЧЕРЕН
БЯЛ
ЧЕРВЕН



- Работно напрежение: 220-240V / 50-60Hz
- Max 15W (ЕСЛ)
- Max 40W



HL 074

ЧЕРЕН
БЯЛ
ЧЕРВЕН



- Работно напрежение: 220-240V / 50-60Hz
- Max 20W (ЕСЛ)
- Max 60W



HL 067

ЧЕРЕН
БЯЛ
ЧЕРВЕН



- Работно напрежение: 220-240V / 50-60Hz
- Max 60W



HL 050

ЧЕРЕН
БЯЛ
ЧЕРВЕН
СИН



- Работно напрежение: 220-240V / 50-60Hz
- Max 60W



HL 090

ЗЕЛЕН
СИН



- Работно напрежение: 220-240V / 50-60Hz
- Max 60W



HL 991L

БЯЛ
СИН
ЗЕЛЕН
ЧЕРВЕН



NEW



• Работно напрежение:
220-240V / 50-60Hz



HL 992L

БЯЛ
СИН
ЗЕЛЕН
ЧЕРВЕН



NEW



• Работно напрежение:
220-240V / 50-60Hz



HL 993L

БЯЛ
СИН
ЗЕЛЕН
ЧЕРВЕН



NEW



• Работно напрежение:
220-240V / 50-60Hz



HL 994L

БЯЛ
СИН
ЗЕЛЕН
ЧЕРВЕН



NEW



• Работно напрежение:
220-240V / 50-60Hz



HL 990L

БЯЛ
СИН
ЖЪЛТ
ЧЕРВЕН
ЗЕЛЕН



NEW



• Работно напрежение:
220-240V / 50-60Hz



HL 980

БЯЛ
СИН
ЖЪЛТ
ЧЕРВЕН
ЗЕЛЕН



• Работно напрежение:
220-240V / 50-60Hz
• 1W



HL 981

БЯЛ
(ПЕЙЗАЖ)



• Работно напрежение:
220-240V / 50-60Hz
• 1.5W



HL 982

БЯЛ
СИН
ЖЪЛТ
ЧЕРВЕН
ЗЕЛЕН



• Работно напрежение:
220-240V / 50-60Hz
• 3W



HL 983

БЯЛ
СИН
ЖЪЛТ
ЧЕРВЕН
ЗЕЛЕН



• Работно напрежение:
220-240V / 50-60Hz
• 1W



HL 984

БЯЛ
СИН
ЖЪЛТ
ЧЕРВЕН
ЗЕЛЕН



• Работно напрежение:
220-240V / 50-60Hz
• 5-7W



HL 985

БЯЛ
СИН
ЖЪЛТ
ЧЕРВЕН
ЗЕЛЕН



• Работно напрежение:
220-240V / 50-60Hz
• 1.5W



HL 986

СИН
ЖЪЛТ
ОРАНЖЕВА
ЗЕЛЕН
ЧЕРВЕН



• Работно напрежение:
220-240V / 50-60Hz
• 1W



HL 004L

ЧЕРВЕН
БЯЛ
ЧЕРЕХ

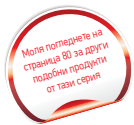

- Работно напрежение: 220-240V / 50-60Hz
- 3W



HL 009L

ЧЕРВЕН
БЯЛ
ЧЕРЕХ

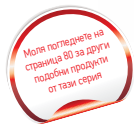

- Работно напрежение: 220-240V / 50-60Hz
- 3W



HL 012L

ЧЕРВЕН
БЯЛ
ЧЕРЕХ



- Работно напрежение: 220-240V / 50-60Hz
- 3W



HL 080

БЯЛ
СИН
ЗЕЛЕН
ОРАНЖЕВА



- Работно напрежение: 220-240V / 50-60Hz
- Max 100W



HL 081

БЯЛ

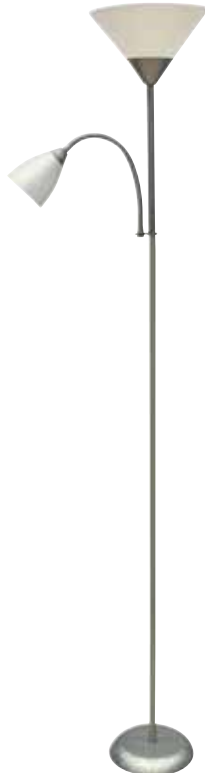

- Работно напрежение: 220-240V / 50-60Hz
- Основен: E27 Max 100W
- Допълнителен: E14 Max 40W



HL 082

БЯЛ

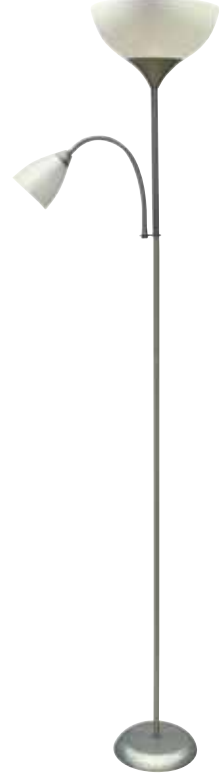

- Работно напрежение: 220-240V / 50-60Hz
- Основен: E27 Max 100W
- Допълнителен: E14 Max 40W



HL 451



Безжичен звънец

- Източник на мощност: Емитер - 12V DC (Включени батерии)
- Приемник: 3V/DC(2x1.5V)
- Работна честота: 433MHz
- Дистанция: 100м.(отворено пространство)
- Ниво на звука: 60 db max
- Тип звук: 16 вида мелодии



HL 452



Безжичен звънец

- Източник на мощност: Емитер - 12V DC (Включени батерии)
- Приемник: 3V/DC(2xAA1.5V)
- Работна честота: 315MHz
- Дистанция: 150м.(отворено пространство)
- Ниво на звука: 60 db max
- Тип звук: 38 вида мелодии



HL 453



Безжичен звънец

- Източник на мощност: Емитер - 12V DC (Включени батерии)
- Приемник: 3V/DC(2xAA1.5V)
- Работна честота: 315MHz
- Дистанция: 150м.(отворено пространство)
- Ниво на звука: 60 db max
- Тип звук: 38 вида мелодии



HL 454



Безжичен звънец

- Работно напрежение: 4.5V DC (3xAA1.5V) или 12V DC адаптор
- Дистанция: 6 м.
- Обхват: 110°
- Ниво на звука: 60 db max
- Тип звук: Динг-Донг, Здравей, Добре дошъл + Аларма



HL 490



Детектор за дим

- Алкална батерия 9 V
- Аларма 85db
- Включени батерии
- Сигнализация за 10 мин.

HL 480

ЧЕРЕН
БЯЛ



- Работно напрежение: 220-240V / 50-60Hz
- Разстояние на задействане: 10 ± 2 м Max. (<24°)
- Време на действие: 5 сек - 8±3 мин.
- Обкръжаваща осветеност: < 10Lux - 2000Lux 20



HL 481

ЧЕРЕН
БЯЛ



- Работно напрежение: 220-240V / 50-60Hz
- Разстояние на задействане: 8 ± 1 м Max. (<24°)
- Време на действие: 5 сек. - 10±2 мин.
- Обкръжаваща осветеност: < 10Lux - 2000Lux 44



HL 482

ЧЕРЕН
БЯЛ



- Работно напрежение: 220-240V / 50-60Hz
- Разстояние на задействане: 8 ± 2 м Max. (<24°)
- Време на действие: 5 сек. - 8±3 мин.
- Обкръжаваща осветеност: < 10Lux - Sunshine 44



HL 483

ЧЕРЕН
БЯЛ



- Работно напрежение: 220-240V / 50-60Hz
- Разстояние на задействане: 8 ± 2 м Max. (<24°)
- Време на действие: 5 сек. - 9 мин.
- Обкръжаваща осветеност: < 3Lux - 1000Lux
- Управление на звука: 30db - 90db



HL 470



- Работно напрежение: 220-240V / 50-60Hz
- Обкръжаваща осветеност: <50Lux
- Ползена мощност: 1000W (6A) 44



HL 471



- Работно напрежение: 220-240V / 50-60Hz
- Обкръжаваща осветеност: <50Lux
- Ползена мощност: 1200W (10A) 44



HL 472



- Работно напрежение: 220-240V / 50-60Hz
- Обкръжаваща осветеност: <50Lux
- Натоварване: 2700W (25A)



ЕЛЕКТРОНИ ДРОСЕЛИ

HL 380 10W
HL 381 15W
HL 382 18W
HL 383 30W
HL 384 36W



HL 385 2x18W
HL 386 2x36W



HL 387 4x18W
HL 388 4x36W



• Работно напрежение:
220-240V / 50-60Hz



ЕЛЕКТРОМАГНИТНИ ДРОСЕЛИ

HL 350 10W За PL или PLC лампи
HL 351 13W За PL или PLC лампи
HL 352 18W За PL или PLC лампи
HL 353 26W За PL или PLC лампи



HL 355 18W За Луминисцентни лампи
HL 356 36W За Луминисцентни лампи



HL 389 125W За живачни лампи
HL 390 250W За живачни лампи
HL 391 400W За живачни лампи



HL 392 70W За Метал Халогенни лампи
HL 393 150W За Метал Халогенни лампи
HL 394 250W За Метал Халогенни лампи
HL 395 400W За Метал Халогенни лампи

• Работно напрежение:
220-240V / 50-60Hz



NEW

ЕЛЕКТРОМАГНИТНИ ТРАНСФОРМАТОРИ

HL 360 12V, 50W



HL 361 12V, 105W



• Работно напрежение:
220-240V / 50-60Hz



ЕЛЕКТРОНИ ТРАНСФОРМАТОРИ

HL 370 12V, 60W
HL 371 12V, 105W
HL 372 12V, 150W



• Работно напрежение:
220-240V / 50-60Hz



ЕЛЕКТРОНИ ТРАНСФОРМАТОРИ

HL 373



• Димирание
• Защита от късо съединение
• Защита от претоварване
• EMC одобрен
• Раб.Н: AC220-240V/50-60Hz,0.23A
• Sec: AC11.6v,4.3A
• Ном.натоварване: 50W
• TA: MAX. 45°C TC: MAX. 70°C

HL 374



• Димирание
• Защита от късо съединение
• Защита от претоварване
• EMC одобрен
• Раб.Н: AC220-240V/50-60Hz,0.46A
• Sec: AC11.6v,8.8A
• Ном.натоварване: 100W
• TA: MAX. 45°C TC: MAX. 70°C



HL 375



• Димирание
• Защита от късо съединение
• Защита от претоварване
• EMC одобрен
• Раб.Н: AC220-240V/50-60Hz,0.60A
• Sec: AC11.6v,12A
• Ном.натоварване: 150W
• TA: MAX. 45°C TC: MAX. 75°C

HL 376



• Димирание
• Защита от късо съединение
• Защита от претоварване
• EMC одобрен
• Раб.Н: AC220-240V/50-60Hz,0.80A
• Sec: AC11.6v,16A
• Ном.натоварване: 200W
• TA: MAX. 45°C TC: MAX. 75°C

HL 377



• Димирание
• Защита от късо съединение
• Защита от претоварване
• EMC одобрен
• Раб.Н: AC220-240V/50-60Hz,1.0A
• Sec: AC11.6v,21A
• Ном.натоварване: 250W
• TA: MAX. 45°C TC: MAX. 75°C



МЕТАЛ ХАЛОГЕННИ ДРОСЕЛИ К-Т

HL 396 70W



• С вградени запалка,
дросел, кондензатор
• Работно напрежение:
220-240V / 50-60Hz

HL 397 150W



NEW

HL 580



HL 581



HL 582



HL 583



HL 584



HL 585



HL 586



HL 587



HL 550

10 cm
15 cm
20 cm



HL 551

15 cm



HL 590



HL 591



HL 592



HL 593



Стартери

S2
S10



220-240V
SINGLE
4-6-8-15
18-22W

110-130V
SINGLE
220-240V
SERIES
4-22W



220-240V
SINGLE
4-65W

Изоляционна лента

10 м / 20 м

БЯЛ
ЖЪЛТ
ЧЕРВЕН
СИН
ЗЕЛЕН
ЧЕРЕН



Ключе с въженце

HL 950



Въженце

NEW



UTP Cat5e Кабел

КАБЕЛ ЗА ИНТЕРНЕТ
305 м. Ролка



Кабелни превръзки

2,5*100
2,5*150
2,5*200
3,6*150
3,6*200
3,6*250
3,6*280
3,6*300
3,6*370
4,8*200
4,8*250
4,8*300
4,8*350
4,8*370
4,8*400
7,2*300
7,2*350
7,2*400
7,2*450
7,9*350
7,9*400
7,9*450
7,9*500
9*550
9*650
9*750
9*1020



Кабелни скоби с гвоздей

КРЪГ	Гвоздей
4 mm	1.7 x 15
5 mm	1.7 x 15
6 mm	1.7 x 17
7 mm	1.8 x 19
8 mm	1.9 x 21
9 mm	2.0 x 22
10 mm	2.05 x 25
12 mm	2.05 x 27
14 mm	2.4 x 32
16 mm	2.5 x 35
18 mm	2.5 x 37
22 mm	2.8 x 48



RG6

Коаксиален кабел
100 м. Ролка



7,1 PVC	Ал.фолио	64x0,16 Ал.сплитки	Ал.фолио свързки	4,57 FPE	1,02 CCS
---------	----------	-----------------------	---------------------	----------	----------



6,8 PVC	64x0,12 Ал.сплитки	Ал.фолио свързки	4,8 FPE	1,02 CCS
---------	-----------------------	---------------------	---------	----------



Лустер клеми

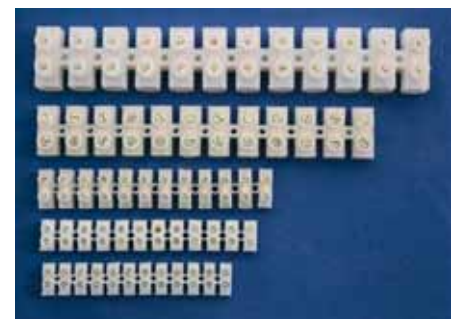

3 A, 4 mm²
5 A, 6 mm²
10 A, 10 mm²
30 A, 16 mm²
60 A, 25 mm²

HL 960

NEW



- Работно напрежение: 220-240V / 50-60Hz
- Въздушен поток: 450
- Скорост: 1200
- Входяща мощност: 35W
- Тегло: 1,8кг.
- Размер: 24.8см x 24.8см x 12.5см



HL 961

NEW



- Работно напрежение: 220-240V / 50-60Hz
- Въздушен поток: 780
- Скорост: 1150
- Входяща мощност: 40W
- Тегло: 2,2кг.
- Размер: 27.5см x 27.5см x 12.5см



HL 962

NEW



- Работно напрежение: 220-240V / 50-60Hz
- Въздушен поток: 890
- Скорост: 1100
- Входяща мощност: 50W
- Тегло: 2,4кг.
- Размер: 33.6см x 33.6см x 13см



ДЕКОРАТИВНО ЛЕД ОСВЕТЛЕНИЕ НАСТОЛНО, ПОДОВО, ЗА КАРТИНИ И ОГЛЕДАЛА



Подови лампиони
HL 004L



Настолни
лампи
HL 001L



Настолни
лампи
HL 002L



Лампи за картини и
огледала
HL 003L



Лампи за картини и
огледала
HL 008L



Настолни
лампи
HL 007L



Настолни
лампи
HL 006L



Подови лампиони
HL 009L



Подови лампиони
HL 012L



Настолни лампи
HL 011L



Настолни лампи
HL 011L



The copyright of
the visual materials
and photographs
used in this catalogue
belongs to Horoz Electric Inc.

Print date: 07/2011
